



Precision Slides

PM - BEARINGS



Introduction

PM - BEARINGS (PM) is specialized in designing and manufacturing linear bearings in top quality. PM is providing a complete range of linear bearings, frictionless slides, positioning tables and stages, which guarantees high levels of performances at competitive prices. Thanks to a long history of experience, new findings in research, combined with innovating linear technology, PM products meet the highest accuracy and quality demands of today's industry and are successful in use worldwide.

Since the foundation in 1966, PM has become an **innovator in linear technology** with the specialization in the production of high- and very high precision linear bearings and frictionless slides.

Starting with the specialization in precision linear bearings PM has expanded and developed the linear-program through the years. Today, PM offers the widest range models and sizes to provide the designer maximum flexibility to achieve the best operating results in linear and rotary motion.

One of the goals is **customer-satisfaction** with additional increase of productivity and reliability against lower production costs. The PM organization is **dedicated to quality** and is focused to give quick and accurate information on customers request.

The main PM-products are published in:

- Linear Bearings
- Precision Slides
- Positioning Tables and Stages
- Linear Bearings for Unlimited Travel

Subassemblies

The growing market for complete subassemblies is fully supported by PM and is a major part of our Total Customer Care strategy. PM is offering not only extensive assembly-facilities, skilled workers and knowledge but also a time- and cost saving solution with increase of flexibility in today's rapid market.

Worldwide Representation

Made by PM means the same high quality, technical support and follow-ups whether in Asia, the U.S.A. or Europe. Our worldwide representatives are selected to serve you with the best technical advice and service guaranteeing fast and reliable deliveries in all local markets. Please, contact PM for the authorized representative in your area.

The specifications and data in this catalogue are believed to be accurate and reliable. However, in the interest of technical progression, PM reserves the right to modify without prior notice.



PM - BEARINGS

Progressive by innovating linear technology



Table of Contents

Page	
1	Introduction
5	Product Overview
6	Technical Data
	General
	Friction
	Lubrication
	Effect of Elevated Temperatures
	Material and Hardness Linear Bearings
	Expected Life
	Wipers and Seals
	Maximum Velocity and Acceleration
	Assembly
	Loads and Moments
	Vacuum & Cleanroom Slides
11	RTN / RTL Frictionless Precision Slides
19	RTNA / RTLA Frictionless Aluminum Slides
27	RTNG Dust-Protected Precision Slides
35	RTAM Frictionless Lightweight Slides
39	RTS Frictionless Low Profile Slides
43	PMM Frictionless Miniature Slides
46	Running Accuracies
47	Special Customer Design



PM - BEARINGS

A complete range

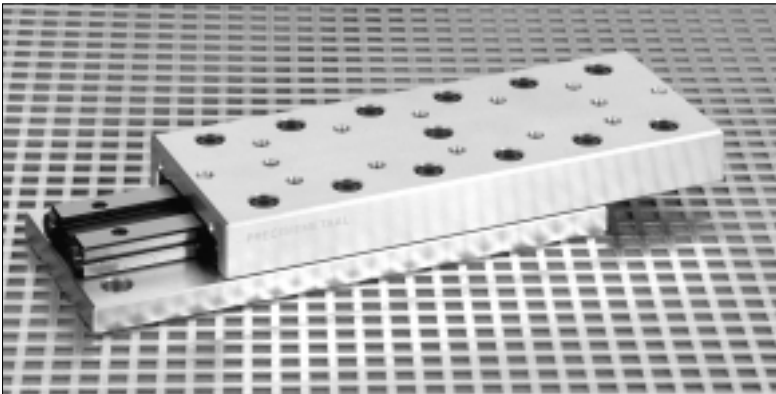

of frictionless slides

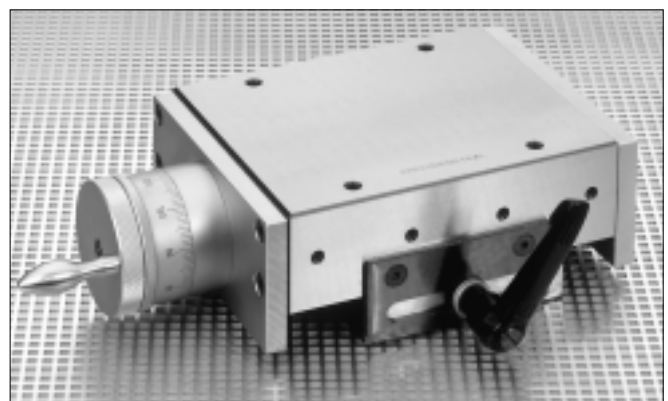
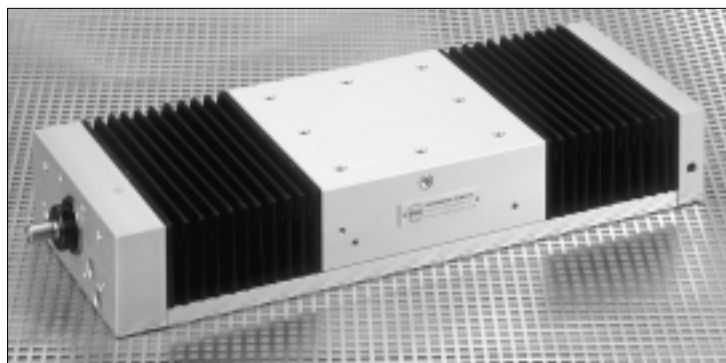

and precision positioning tables



Product Overview

PM - BEARINGS frictionless slides, are ready-to-install 1-axis components for limited linear movements. The crossed roller slides use PM linear bearings type RSD, are factory pre-loaded. This, to assure a consistent high running accuracy, extreme low uniform coefficient of friction and a long operation lifetime. With various models and over a broad range of sizes, it offers the designer maximum flexibility to find a sufficient solution for each individual application in which a linear movement is required.

Each type is executed with attachment holes drilled to a

standard configuration to permit a quick and easy assembly in your application.

Thanks to the excellent running characteristics together with the well proven reliability, these slides are today's standard for application in the general machine industry up to high precision equipments.

Special executions will be supplied according to your specifications.

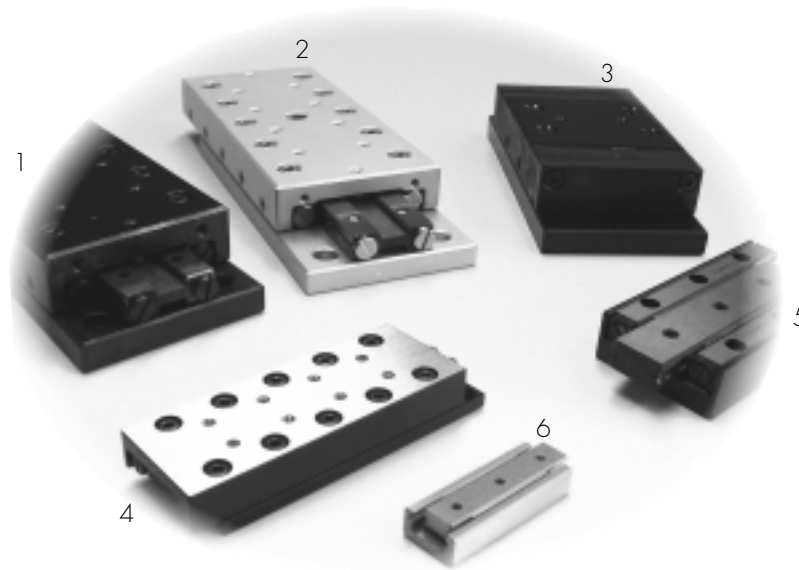

1. Crossed roller slides type RT

- Strokelenlengths 10-950 mm
- For highest accuracy performances
- Normal up to high load capacity
- Steel and cast-iron table bodies
- 6 sizes

2. Crossed roller slides lightweight type RTA

- Strokelenlengths 10-950 mm
- Extreme low friction resistance
- Setting standards in accuracy performances
- Aluminum table bodies
- 6 sizes

3. Dust-protected slides type RTNG

- Strokelenlengths 10-250 mm
- Protected against dust and chips
- For highest accuracy performances
- Steel and cast-iron table bodies
- High rigidity

4. Crossed roller slides lightweight type RTAM

- Strokelenlengths 25-76 mm
- For enhanced operation lifetime
- Low and compact design
- Aluminum table bodies
- 1 size and 6 lengths

5. Crossed roller slides low profile type RTS

- Strokelenlengths 12-130 mm
- For highest accuracy performances
- Low profile and high rigid design
- Steel table bodies
- 3 sizes

6. Miniature ball slides type PMM

- Strokelenlengths 5-70 mm
- Ultra-compact and lightweight design
- For rapid and precise movements
- Stainless steel table bodies
- 3 sizes



Technical Data

General

The PM range of linear bearings and "almost frictionless" precision slides are available in various sections with matching ball- and roller diameter in a wide range of standard lengths.

The choice of sizes (cross-sections) and lengths caters for almost all load capacities, enabling the designer to solve most linear motion problems with virtual frictionfree movements, free from play, with adjustable pre-load. Due to these features PM linear bearings are almost complete free from wear, needing only minimum lubrication and maintenance, and are used successfully in a wide range of industries, e.g.:

- Packing machinery
- Machine tools + other metal working machinery
- Automation applications
- Special purpose machines + special purpose tooling

Due to the high linear accuracy, which PM linear bearings offers, they are also used widely for:

- Measuring instruments
- Tool setting equipments
- Robotic devices
- Space applications
- Research projects
- Semiconductor equipments

To sum up, PM's full assembled frictionless linear slides, have a compact size, offer facility of installation, high accuracy of running motion, long life with only minimal lubrication, low maintenance costs, and ease of replacement in the event of damage. Because the linear bearings and linear slides are vital components in the application they are manufactured with the greatest care to provide the maximum of linear accuracy and reliability that is likely to be required.

Friction

PM frictionless slides give an unprecedented friction coefficient of <0.003 . Through this, the characteristics of the linear slides in combination with a correct mounting and lubrication find the best way for expression.

Friction is the force necessary to move a body along a horizontal plane or track. A fine machined surface gives a positive effect on the friction. Therefore PM is using the highest quality of roller bodies in combination with precision ground anti-friction guideways type RSD which are manufactured by a team of specialists. Compared with other types of friction, linear bearings fitted with balls or rollers offer not only much lower frictional resistance, but also an almost complete absence of static friction.

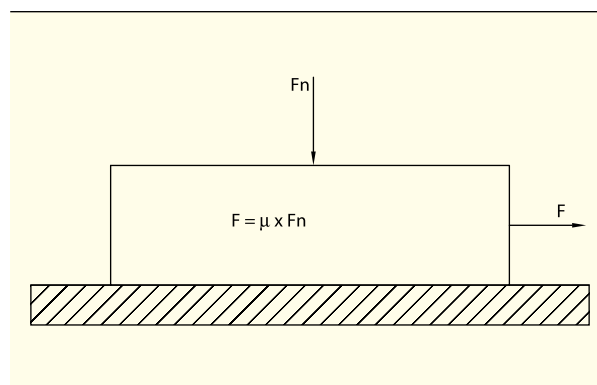

- μ = Coefficient of friction
- F_n = Normal force
- F = Frictional resistance

Note: wipers and seals give a negative reaction on the friction.

Lubrication

PM precision guides and slides are a main part in the construction of machines. The standardized high quality has to be secured during the calculated lifetime. Nevertheless dust and moisture are the main enemies of the precision bearings. Lubrication creates a film between the rolling surfaces and gives a sufficient protection against corrosion. Other benefits are for example:

- Friction reduction
- Reduction of wear
- Prolongation of lifetime
- Transport of heat

We prefer lubrication by oil CLP like DIN 51519 and HLP like DIN 51524. During operation the temperature has to be between -30°C till $+120^{\circ}\text{C}$ while the viscosity is between ISO-VG15 and ISO-VG100. Frictionless slides will be supplied with a sufficient oil lubrication. This lubrication, depending on the condition of use and the environment, will be working for years. However, experience has shown that a regular lubrication has a positive effect on the operation lifetime. By the application of PM precision guides which are manufactured of not standardized materials or used in special operation environments the lubrication has to be taken into account. For further information, please contact PM - BEARINGS.



Effect of Elevated Temperatures

PM slides can be used by temperatures between -40°C up to +80°C during operation. In case of doubt or questions by the use of motors, ball screws, measuring systems etc. please consult PM - BEARINGS.

When PM linear bearings are used at temperatures in excess of 150 °C, the track-rail hardness begins to fall off and the load ratings must be reduced in accordance with factor f_t , tabulated below. If different elements of a linear bearing assembly, which has been pre-loaded or adjusted for freedom of play, suffers differential temperatures, then this could have harmful effects. In the worst case, the pre-load can become excessive and cause Brinell-type indentations in the bearing ways. Accordingly, if high demands are placed on running accuracy, then such temperature differentials must be avoided.

Temperature in °C	Temperature factor f_t
125	1
150	1
175	0.95
200	0.90
225	0.82
250	0.76
275	0.68
300	0.61

Fahrenheit: 1 deg F= 0.5556 °C

Material and Hardness Linear Bearings

The guideways are manufactured of bearing steel 1.2842 or 1.3505 and are trough-hardened to 58-62 Hrc. The cylindrical rollers and balls are made of bearing steel 1.3505 with an hardness value of 58-66 Hrc, and are used in the highest grade quality. Only in cases, where the hardness is less than 58 Hrc (as for rust-resisting steels) the rated loads have to be reduced in accordance with the hardness factor f_h , tabulated.

Hardness			Hardness factor f_h
Rockwell Hrc.	Vickers HV	Brinell HB	
60	697	-	1
59	674	-	1
58	653	-	1
57	633	-	0.96
56	613	-	0.89
55	595	-	0.81
54	577	-	0.75
53	560	-	0.71
52	544	500	0.67
51	528	487	0.63
50	513	475	0.60

Load ratings, which are quoted in this catalog, actually refer to a Rockwell hardness of 58 Hrc.

Expected Life

To estimate the expected life for linear bearings the following calculation can be employed, providing that the recommended installation conditions, lubrication, and protection from dust and dirt are maintained.

$$L = (C/P)^e \times 1,15 \times f_t \times f_h \times 10^5 \text{ metres}$$

- L = expected life in metres.
- C = effective dynamic load rating in N.
- P = equivalent load in N.
- e = 10/3 for rollers and needle rollers, and 3 for balls.
- 1,15 = an empirical factor applicable to the materials employed.
- f_t = correction factor for temperature effects. (see above)
- f_h = correction factor for guideway hardness grades. (i.e.: below 58 Hrc)



Wipers and Seals

Whenever our linear bearings are installed under unfavourable ambient conditions, it is advisable to protect them from the ingress of dust and dirt. For anti-friction guideways type RSD, RSDE, N+O/M+V special endstops with felt-wipers can be supplied, optional to order. There are also fully enclosed RTNG-slides, with a small air-gap which acts as a seal (the necessary extension of the slide-base results in a considerable increase in length compared with standard units). For other sealing arrangements, or wipers, please enquire PM - BEARINGS.

Maximum Velocity and Acceleration

RSD + RSDE series linear bearings:

Max. recommended speed $v = 50$ m/min.

Max. acceleration $a = 8$ m/sec².

N+O type linear bearings:

Max. recommended speed $v = 50$ m/min.

Max. acceleration $a = 150$ m/sec².

(depending on type of bearing-cage used)

To attain maximum acceleration and speeds without skidding of balls or rollers (which can result in cage creeping) the bearings must be suitable pre-loaded (for details please enquire).

For higher accelerations and dynamics with our slide tables we provide modifications, please enquire PM-Bearings.

Assembly

The mounting holes of each type are drilled to a standard configuration in slide-top and -base and permit the user a quick attachment into the application. Thread holes in the table parts are according to ISO-standard. Dimensions in this catalogue are in mm.

PM linear slides are precision devices and require proper mounting to perform at rated specifications. They have to be mounted on rigid and fine-machined, preferable by fine-milling, flat surfaces and supported over their entire base length. Hereby the characteristic qualities of a PM linear slide will be shown to full advantage.

Loads and Moments

The slides listed in this catalogue are able to carry loads and moments in any direction. The load ratings are based on the fundamentals established by ISO and DIN for the calculation of roller bearings (ISO standard 281, for miniature slide type PMM DIN 636, part 3). To ensure the high running accuracy and to prevent against play, vibration and overloads have to be avoided. The load capacity C , defined in ISO76-1987, is the maximum downward load or force located in the center of the upper part in horizontal

zero-position.

Moment Load: the max. allowable moment load capacities listed in this catalog are created in three orientations

M_l = pitch moment: when a load is cantilevered (not symmetrically mounted) off the end of an axis, parallel to the direction of travel.

M_d = roll moment: when a load is cantilevered off the side of an axis, perpendicular to the direction of travel.

M_r = yaw moment: when a force causes a rotation moment about the center of an axis.

Exceeding of the listed moment ratings may reduce the life of the bearings and can degrade accuracy. Please feel free to contact one of our product specialists for more information.

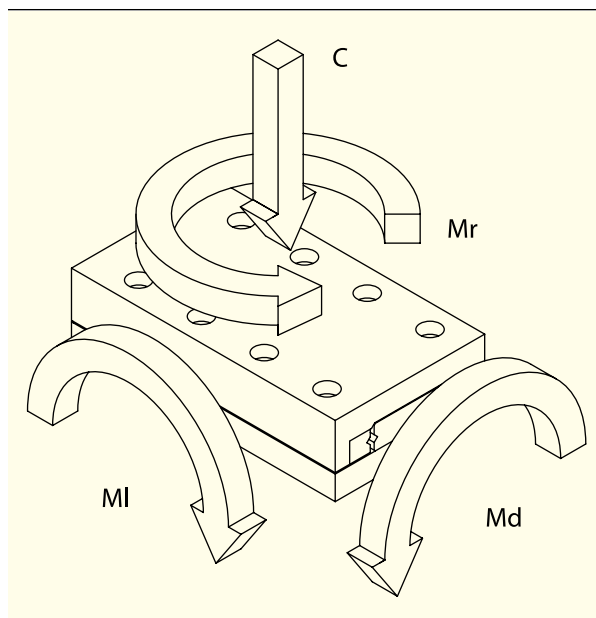

Vacuum and Cleanroom Compatible Slides

Most of the PM slides can be prepared for use in (ultra- high) vacuum or cleanroom environments. Special care has to be taken for example with the selection of the low outgassing materials, special lubricants, surface finishings, vented stainless steel fasteners for use in blind tapped holes, special ball- or crossed roller-cages and with the selection of switches and wires. For the assembly of the tables we use modern clean-room cells upto ISO/FDIS 14644-1 class 5 with cleanspots class 3.

With over 35 years experience in this field we are ready to meet the most challenging requirements.

For more information please consult PM.





News Release

NEW QUALITY GRADE SF-CLASS FOR LINEAR BEARINGS OFFERS MAXIMUM PERFORMANCE

Dedemsvaart – The Netherlands, September 6, 1999

PM – BEARINGS BV (PM) announces a new innovative quality grade for their crossed roller bearings – Option SF-class. SF-Class (Super Finish) is used in certain optical and electronic scanning applications where vibrations can affect the reading of accuracy of the system. Other applications are fiber optic splicing equipments and wire bonding stages which require the highest class in accuracy and reliability. SF class offers a runout of no more than 2 micron over a travel distance of 1200mm.



The highly polished V-grooves provide the smoothest motion of any mechanical bearing system together with an extremely consistent virtually zero frictional force, which make this bearing well suited for applications where a precise reading of axial force must be obtained. The surface roughness of the V-grooves is less than 0.05 Ra instead of conventional guides with 0.1 Ra.

PM 's SF-class can provide linear travel in sub-micron range and is now available in all precision crossed roller slides and positioning tables.

PM is a leading manufacturer of high precision linear bearings, slides and stages. Their products are meeting the highest accuracy and quality demands of today's industry and are successful in use worldwide. The wide range of products offers designers maximum flexibility to match every requirement in linear and rotary motion applications.

For more information:

PM – BEARINGS BV
Phone: +31 (0)523 612 258
Fax: +31 (0)523 615 290
Website: www.pmbearings.nl



Frictionless Precision Slides

RTN / RTL



PM frictionless precision slides type RTN and RTL are pre-loaded linear motion components, ready for mounting. The well proven design of this model offers a wide range of benefits as for example; high rigidity, no stick-slip effect and an unprecedented precision in linear movement thanks to the installation of a double-sided track-rail on the slide-base which eliminates machining errors on the slide-base.

Material Table Bodies

Size Ø1.5, Ø2, Ø3mm and Ø4mm: steel, black oxide finish.

Size Ø6 and Ø9mm: cast-iron, black oxide finish.

Features and Specifications

- Incorporates pre-loaded linear bearings type RSD and double-side track-rail, including roller cages.
- Slide-top and -base have equal lengths.
- 2 standard strolengths (N- and L-stroke).
Linear strokes are limited by internal mounted end-stops, two in the slide-top and one or two in the base-plate, depending on RTL or RTN version.
N-stroke: for normal stroke/travel, with normal loads
L-stroke: for longer stroke/travel, with reduced loads
- Size Ø1.5 and Ø2 mm: use in each direction (with brass roller cage type CC).
Size Ø3, Ø4, Ø6 (pitch t=9mm) and Ø9mm (pitch t=14mm): horizontal fitting model (with steel roller cage type AA).
Vertical fitting model (with brass roller cage type DD).
- All mounting surfaces are precision ground.
One flank of the slide (the side opposite to the adjustment screws) is ground parallel to the linear bearings to serve as a Reference Face.
- The slide-top is provided with tapped attachment holes, drilled to a standard configuration. The slide-base is equipped with countersunk-bored holes, which accept sockethead screws.
- Running accuracies are shown on page 46.

Options

- Selected slides can be supplied with an height tolerance of ± 0.01 mm.
- Cages can be replaced by plastic crossed roller cages type KZR or type KKLK for balls.
- Higher accuracy grade slides.
- Stainless steel version.
- SF-Class technology for maximum performance.
- High vacuum modification.

Notes by ordering

By ordering please specify the following:

1. Model no. and quantity.
2. Direction of linear movement (horizontal, vertical or "in between", only size Ø3, Ø4, Ø6 and Ø9mm).

Example: 1 piece slide type RTN-3250-Vert.



RTN / RTL

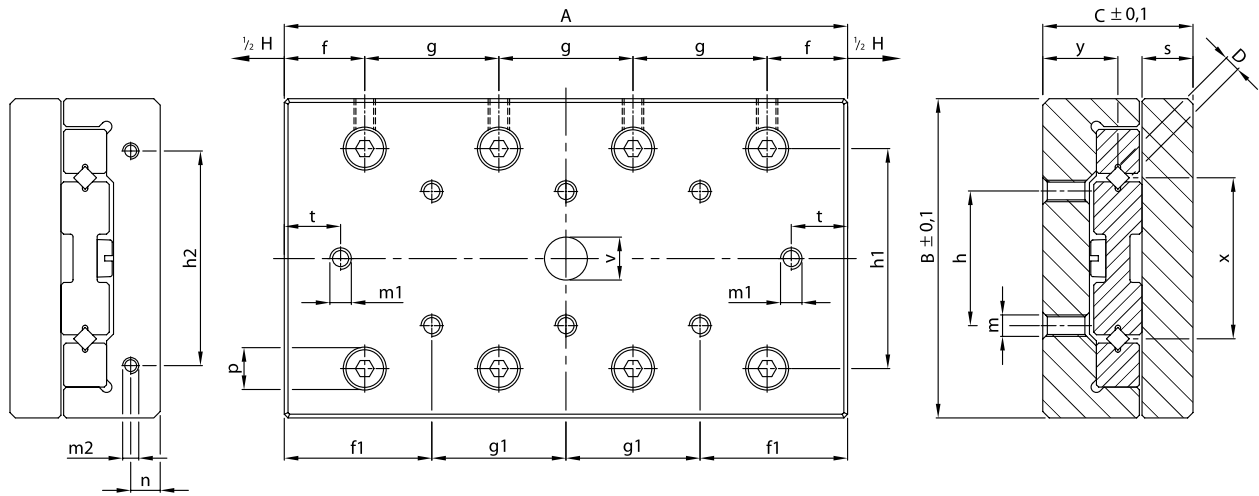

Layout mounting holes slide-base at page 16

Type	mm				Travel H		f	f1	g	g1	h	h1	h2	m	m1	m2	
	A	B	C	D	RTN	RTL											
RT- 1520	25				10	-			1 x 10	-							
RT- 1530	35				15	20			2 x 10	1 x 10							
RT- 1540	45				20	30			3 x 10	2 x 10							
RT- 1550	55				25	40			4 x 10	3 x 10							
RT- 1560	65	29.6	17	1.5	30	50	7.5	12.5	5 x 10	4 x 10	10	18.4	12	M2.5	M2	M2	
RT- 1570	75				35	60			6 x 10	5 x 10							
RT- 1580	85				40	70			7 x 10	6 x 10							
RT- 1590	95				45	80			8 x 10	7 x 10							
RT-15100	105				50	90			9 x 10	8 x 10							
RT- 2030	35				15	-			1 x 15	-							
RT- 2045	50				22	30			2 x 15	1 x 15							
RT- 2060	65				30	45			3 x 15	2 x 15							
RT- 2075	80				37	60			4 x 15	3 x 15							
RT- 2090	95	39.6	21	2	45	75	10	17.5	5 x 15	4 x 15	15	25	16	M3	M2.5	M2	
RT- 2105	110				52	90			6 x 15	5 x 15							
RT- 2120	125				60	105			7 x 15	6 x 15							
RT- 2135	140				67	120			8 x 15	7 x 15							
RT- 2150	155				75	135			9 x 15	8 x 15							
RT- 3050	55				-	30			1 x 25	-							
RT- 3075	80				37	55			2 x 25	1 x 25							
RT- 3100	105				50	80			3 x 25	2 x 25							
RT- 3125	130				62	105			4 x 25	3 x 25							
RT- 3150	155				75	130			5 x 25	4 x 25							
RT- 3175	180	59.5	28	3	87	155	15	27.5	6 x 25	5 x 25	25	41	40	M4	M4	M3	
RT- 3200	205				100	180			7 x 25	6 x 25							
RT- 3250	255				125	230			9 x 25	8 x 25							
RT- 3300	305				150	280			11 x 25	10 x 25							
RT- 3350	355				175	330			13 x 25	12 x 25							
RT- 3400	405				200	380			15 x 25	14 x 25							



RTN / RTL

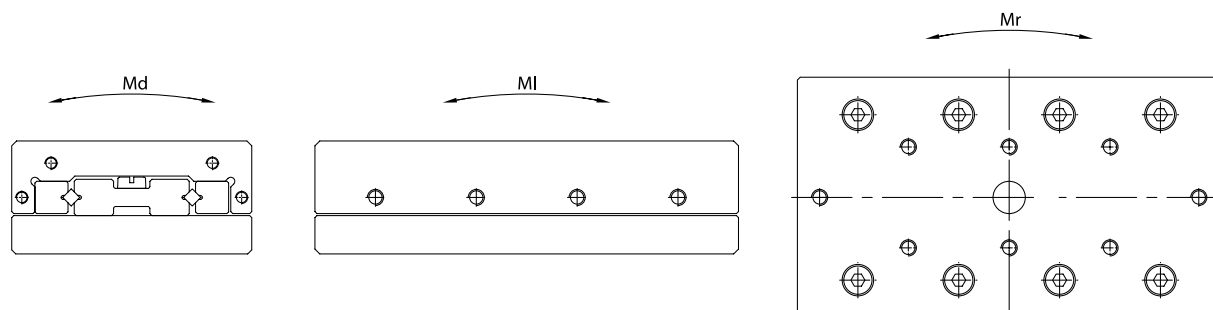

n	p	s	t	v	x	y	C in N		Weight in Kg	Md in Nm		MI in Nm		Mr in Nm	
							RTN	RTL		RTN	RTL	RTN	RTL	RTN	RTL
2.45							260	-	0.10	1.4	-	1.2	-	1.5	-
2.5							364	312	0.12	2.1	2.1	2.5	1.9	1.9	1.7
3							520	416	0.16	3.5	2.8	4.4	3.1	2.6	2.1
4							624	520	0.19	4.2	3.5	5.6	4.4	3.1	2.6
2.5	4.6	6	3.7	4.5	13.5	8.75	780	572	0.23	4.9	3.5	7.5	5.0	4.0	2.9
5							884	676	0.27	5.6	4.2	8.7	6.2	4.6	3.4
6							1040	780	0.30	7.0	4.9	10.6	7.5	5.5	4.0
7							1144	832	0.34	7.7	5.6	11.9	8.1	6.1	4.3
8							1300	936	0.37	8.4	6.3	13.7	9.4	7.0	4.9
9							430	-	0.19	3.1	-	2.8	-	3.4	-
10							688	602	0.28	6.2	4.6	6.9	5.5	4.6	4.1
11							946	774	0.38	7.7	6.2	11.0	8.3	6.3	5.2
12							1204	946	0.47	10.8	7.7	15.1	11.0	8.2	6.3
3.4	6.3	7	5.5	5.5	18	10.75	1376	1118	0.56	12.4	9.3	17.9	13.8	9.5	7.5
13							1634	1290	0.65	13.9	10.8	22.0	16.5	11.4	8.8
14							1892	1376	0.75	17.0	12.4	26.1	17.9	13.4	9.5
15							2150	1548	0.84	18.6	13.9	30.3	20.6	15.4	10.8
16							2408	1720	0.93	21.7	15.5	34.4	23.4	17.5	12.1
17							-	952	0.64	-	12.2	-	10.9	-	5.4
18							1496	1224	0.94	20.4	16.3	21.8	16.3	13.6	11.5
19							2040	1632	1.24	28.6	24.5	32.6	24.5	18.2	14.7
20							2448	1904	1.55	36.7	28.6	40.8	29.9	22.0	17.0
21							2992	2312	1.86	44.9	32.6	51.7	38.1	27.1	20.7
5.5	7.8	9.5	5.5	8	30	14	3536	2584	2.15	53.0	36.7	62.6	43.5	32.3	23.2
22							4080	2992	2.46	61.2	44.9	73.4	51.7	37.6	27.1
23							5032	3672	3.06	73.4	53.0	92.5	65.3	47.0	33.6
24							6120	4352	3.66	89.8	65.3	114.2	78.9	57.7	40.3
25							7072	5032	4.27	106.1	73.4	133.3	92.5	67.1	47.0
26							8160	5712	4.87	122.4	85.7	155.0	106.1	77.9	53.7

RTN / RTL

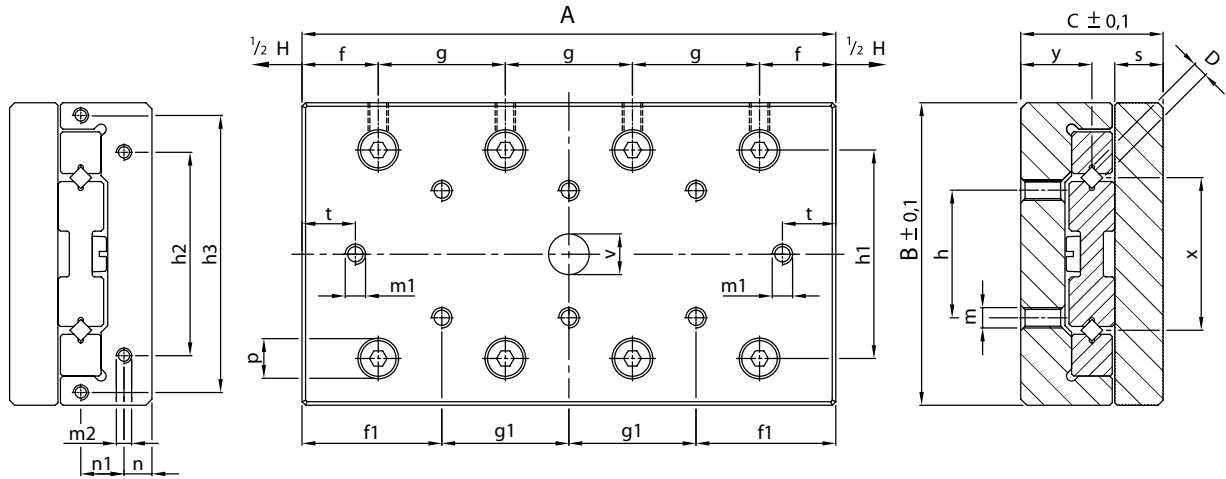

Layout mounting holes slide-base at page 17

Type	mm A	B	C	D	Travel H		f	f1	g	g1	h	h1	h2	h3	m	m1
					RTN	RTL										
RT- 4080	85				50	-			1 x 40	-						
RT- 4120	125				75	90			2 x 40	1 x 40						
RT- 4160	165				105	130			3 x 40	2 x 40						
RT- 4200	205				130	170			4 x 40	3 x 40						
RT- 4240	245	80	35	4	155	210	22.5	42.5	5 x 40	4 x 40	40	53	55	-	M5	M5
RT- 4280	285				185	250			6 x 40	5 x 40						
RT- 4320	325				210	290			7 x 40	6 x 40						
RT- 4360	365				235	330			8 x 40	7 x 40						
RT- 4400	405				265	370			9 x 40	8 x 40						
RT- 6100	110				50	70			1 x 50	-						
RT- 6150	160				75	120			2 x 50	1 x 50						
RT- 6200	210				100	170			3 x 50	2 x 50						
RT- 6250	260				125	220			4 x 50	3 x 50						
RT- 6300	310				150	270			5 x 50	4 x 50						
RT- 6350	360	99.5	45	6	175	320	30	55	6 x 50	5 x 50	50	65	60	92	M6	M6
RT- 6400	410				200	370			7 x 50	6 x 50						
RT- 6450	460				225	420			8 x 50	7 x 50						
RT- 6500	510				250	470			9 x 50	8 x 50						
RT- 6600	610				300	570			11 x 50	10 x 50						
RT- 6700	710				350	670			13 x 50	12 x 50						
RT- 9100	110				50	-	30	55	1 x 50	-						
RT- 9200	210				100	150			1 x 100	-						
RT- 9300	310				150	250			2 x 100	1 x 100						
RT- 9400	410				200	350			3 x 100	2 x 100						
RT- 9500	510	148	60	9	250	450	55	105	4 x 100	3 x 100	100	104	90	135	M8	M8
RT- 9600	610				300	550			5 x 100	4 x 100						
RT- 9700	710				350	650			6 x 100	5 x 100						
RT- 9800	810				400	750			7 x 100	6 x 100						
RT- 9900	910				450	850			8 x 100	7 x 100						
RT- 91000	1010				500	950			9 x 100	8 x 100						

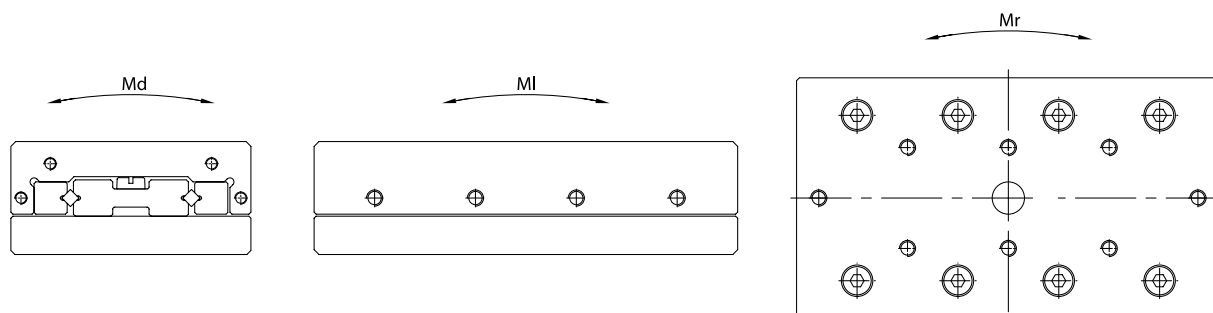

m2	n	nl	p	s	t	v	x	y	C in N		Weight in Kg	Md in Nm		MI in Nm		Mr in Nm	
									RTN	RTL		RTN	RTL	RTN	RTL	RTN	RTL
M3	6.5	-	10	10.5	9	9.5	40	18.5	1855	-	1.70	31.8	-	29.7	-	25.9	-
									2915	2650	2.50	53.0	53.0	59.4	51.9	36.5	33.5
									3710	3445	3.30	74.2	63.6	81.6	74.2	46.0	42.7
									4770	4240	4.10	95.4	84.8	111.3	96.5	59.6	52.7
									5830	4770	4.90	116.6	95.4	141.0	111.3	73.6	59.6
									6890	5565	5.70	137.8	106.0	170.7	133.6	87.9	70.1
									7950	6360	6.50	159.0	127.2	200.3	155.8	102.4	80.7
									9010	7155	7.30	180.2	137.8	230.0	178.1	116.9	91.5
									9805	7950	8.10	190.8	159.0	252.3	200.3	127.9	102.4
M4	8	15	11	14	10	11	46	23	4320	3780	3.30	97.2	72.9	97.2	77.8	68.7	62.2
									6480	5400	4.84	145.8	121.5	175.0	136.1	100.1	83.6
									8640	6480	6.37	194.4	145.8	252.7	175.0	135.4	100.1
									10800	8100	7.91	243.0	170.1	330.5	233.3	172.2	126.4
									13500	9720	9.44	291.6	218.7	427.7	291.6	219.3	153.7
									15660	11340	11.00	340.2	243.0	505.4	349.9	257.4	181.6
									17820	12420	12.54	388.8	267.3	583.2	388.8	295.6	200.4
									19980	14040	14.07	437.4	315.9	661.0	447.1	334.0	228.8
									22140	15660	15.60	486.0	340.2	738.7	505.4	372.5	257.4
									27000	18900	18.65	607.5	413.1	913.7	622.1	459.4	314.8
									31320	21600	21.71	704.7	486.0	1069.2	719.3	536.8	362.9
M4	11	20	14	17	17	14	78	31	6750	-	6.50	210.6	-	151.2	-	223.8	-
									13500	10800	12.64	526.5	421.2	529.2	378.0	338.2	283.0
									21600	16200	18.86	842.4	631.8	982.8	680.4	534.6	400.1
									28350	21600	25.08	1053.0	842.4	1360.8	982.8	712.2	534.6
									35100	25650	31.20	1368.9	947.7	1738.8	1209.6	894.5	640.4
									43200	31050	37.41	1684.8	1158.3	2192.4	1512.0	1116.2	784.8
									49950	35100	43.53	1895.4	1368.9	2570.4	1738.8	1302.3	894.5
									56700	40500	49.75	2211.3	1579.5	2948.4	2041.2	1489.2	1042.1
									64800	44550	55.96	2527.2	1684.8	3402.0	2268.0	1714.0	1153.4
									71550	49950	62.08	2737.8	1895.4	3780.0	2570.4	1901.7	1302.3

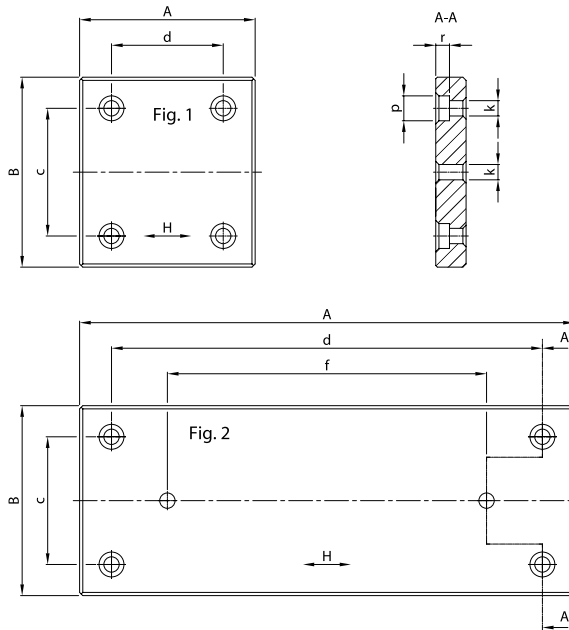

Type	mm A	B	c	d	e	f	g	k	p	r	Fig.
RT- 1520	25			17	-	-	-				1
RT- 1530	35			27	-	-	-				1
RT- 1540	45			37	-	-	-				1
RT- 1550	55			47	-	25	-				2
RT- 1560	65	29.6	22	57	-	30	-	3	5	2.5	2
RT- 1570	75			67	-	35	-				2
RT- 1580	85			77	-	40	-				2
RT- 1590	95			87	-	45	-				2
RT- 15100	105			97	-	50	-				2
RT- 2030	35			25	-	-	-				1
RT- 2045	50			40	-	-	-				1
RT- 2060	65			55	-	-	-				1
RT- 2075	80			70	-	-	-				1
RT- 2090	95			85	-	45	-				2
RT- 2105	110	39.6	30	100	-	50	-	3.8	6.3	3.3	2
RT- 2120	125			115	-	30	-				2
RT- 2135	140			130	-	40	-				2
RT- 2150	155			145	-	40	-				2
RT- 3050	55			35	-	-	-				1
RT- 3075	80			60	-	-	-				1
RT- 3100	105			85	-	-	-				1
RT- 3125	130			110	-	-	-				1
RT- 3150	155			135	-	75	-				2
RT- 3175	180	59.5	40	160	-	86	-	4.8	7.8	4.3	2
RT- 3200	205			185	-	55	-				2
RT- 3250	255			235	145	55	-				3
RT- 3300	305			285	165	65	-				3
RT- 3350	355			335	195	75	-				3
RT- 3400	405			385	225	85	-				3

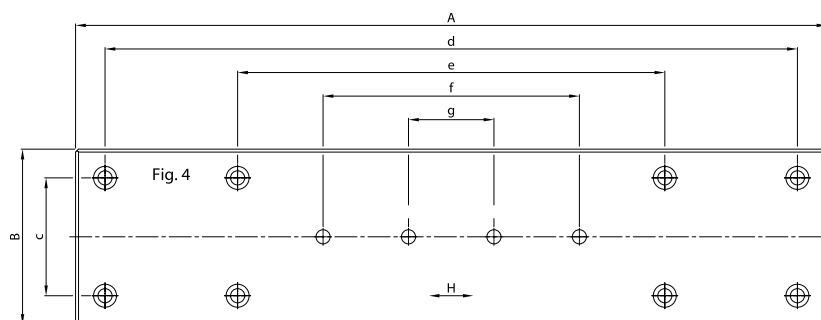
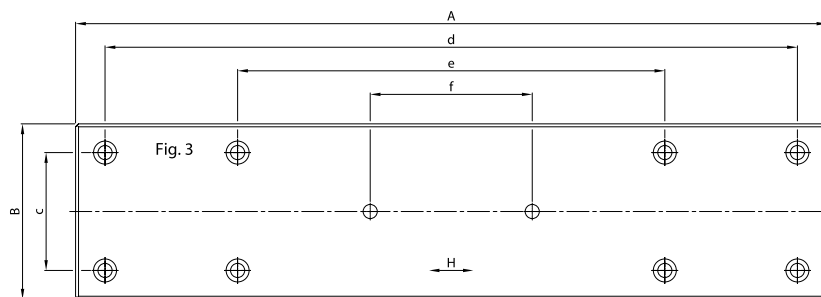

Type	mm A	B	c	d	e	f	g	k	p	r	Fig.
RT- 4080	85			65	-	-	-				1
RT- 4120	125			105	-	-	-				1
RT- 4160	165			145	-	-	-				1
RT- 4200	205			185	-	105	-				2
RT- 4240	245	80	55	225	-	145	-	5.5	10	5.4	2
RT- 4280	285			265	-	185	-				2
RT- 4320	325			305	145	225	-				3
RT- 4360	365			345	185	265	-				3
RT- 4400	405			385	225	305	-				3
RT- 6100	110			90	-	-	-				1
RT- 6150	160			140	-	-	-				1
RT- 6200	210			190	-	100	-				2
RT- 6250	260			240	-	120	-				2
RT- 6300	310			290	-	150	-				2
RT- 6350	360	99.5	60	340	200	80	-	6.8	11	6.3	3
RT- 6400	410			390	230	90	-				3
RT- 6450	460			440	260	100	-				3
RT- 6500	510			490	290	110	-				3
RT- 6600	610			590	350	210	70				4
RT- 6700	710			690	410	250	90				4
RT- 9100	110			80	-	-	-				1
RT- 9200	210			100	-	-	-				1
RT- 9300	310			200	-	-	-				1
RT- 9400	410			300	-	180	-				2
RT- 9500	510	148	90	400	-	240	-	9	14	8.7	2
RT- 9600	610			500	340	120	-				3
RT- 9700	710			600	400	140	-				3
RT- 9800	810			700	460	280	100				4
RT- 9900	910			800	520	320	120				4
RT- 91000	1010			900	600	360	120				4



News Release

PM LINEAR BEARINGS AND TABLES NOW AVAILABLE WITH THE FIRST STANDARDIZED ANTI-CAGE CREEP SOLUTION

Dedemsvaart – The Netherlands, February 21, 2001

PM – BEARINGS BV (PM) announces the introduction of the first standardized Anti-Cage Creep (ACC) option for their crossed roller bearings RSDE and frictionless crossed roller tables (slides).

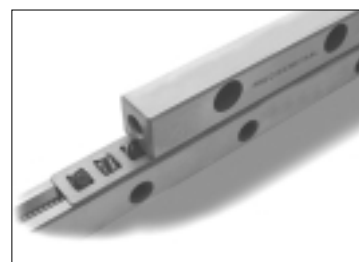

Cage creep can occur in non-recirculating linear bearing applications where vibrations, improper mounting, very high-acceleration and de-acceleration, inadequate tolerances on the mounting surfaces, uneven preload or moment loading are present. Cage creep often results in reduction of travel length and premature wear of the linear bearings.

The ACC option is designed for use in high-tech and extreme dynamic applications like wire bonding tables and pick and place units. It has proven ability to prevent cage creeping in the most demanding applications and the most severe test environment conditions. The ACC option is an all metal design and is integrated in the design of the linear bearing without influencing the external boundary or mounting dimensions. This allows the user to replace the bearings in existing problem applications in all orientations by the ACC option without any machine modification.

ACC can operate under temperatures of -40°C up to +80°C which is a significant advantage over similar systems using plastic components. This also makes it suitable for vacuum applications.

Max. acceleration = 15G

PM 's ACC option can provide linear travel in micron range with virtually zero friction and is now available in precision crossed roller bearings RSDE in sizes 3, 4, 6 and 9mm.

PM is a leading manufacturer of high precision linear bearings, slides and stages. Their products are meeting the highest accuracy and quality demands of today's industry and are successful in use worldwide. The wide range of products offers designers maximum flexibility to match every requirement in linear and rotary motion applications.

For more information:

PM – BEARINGS BV

Phone: +31 (0)523 612 258

Fax: +31 (0)523 615 290

Website: www.pmbearings.nl



Frictionless Aluminum Slides

RTNA/ RTLA



PM frictionless slides type RTNA and RTLA are fine pre-loaded linear motion components, ready for mounting. Mainly made in aluminum, this model offers a wide range of benefits as for example; low weight, no stick-slip effect and easy to mount into the application. These slides are designed to meet the demands of general machine industry upto high precision equipments.

Material Table Bodies

Aluminum, clear anodized finishing.

Features and Specifications

- Incorporates pre-loaded linear bearings type RSD and double-sided track-rail, including roller cages.
- Slide-top and -base have equal lengths.
- 2 standard strolengths (N- and L-stroke).
Linear strokes are limited by internal mounted end-stops, two in the slide-top and one or two in the base-plate, depending on RTLA or RTNA version.
N-stroke: for normal stroke/travel, with normal loads.
L-stroke: for longer stroke/travel, with reduced loads.
- Size Ø1.5 and Ø2 mm: use in each direction (with brass roller cage type CC).
Size Ø3, Ø4, Ø6 (pitch t=9 mm) and Ø9mm (pitch t=14mm), horizontal fitting model (with steel roller cage type AA).
Vertical fitting model (with brass roller cage type DD).
- All mounting surfaces are precision ground.
One flank of the slide (the side opposite to the adjust ment screws) is ground parallel to the linear bearings to serve as a Reference Face.
- The slide-top is provided with tapped attachment holes, drilled to a standard configuration. The slide-base is equipped with countersunk-bored holes, which accept sockethead screws.
- Running accuracies are shown on page 46.

Options

- Cages can be replaced by plastic crossed roller cages type KZR or type KKLK fitted with balls.
- Higher accuracy grade slides.
- Stainless steel version.
- SF-Class technology for maximum performance.
- High vacuum modification.

Notes by ordering

By ordering please specify the following:

1. Model no. and quantity.
2. Direction of linear movement (horizontal, vertical or "in between", only size Ø3, Ø4, Ø6 and Ø9mm).

Example: 1 piece slide type RTNA-3250-Vert.



RTNA/ RTLA

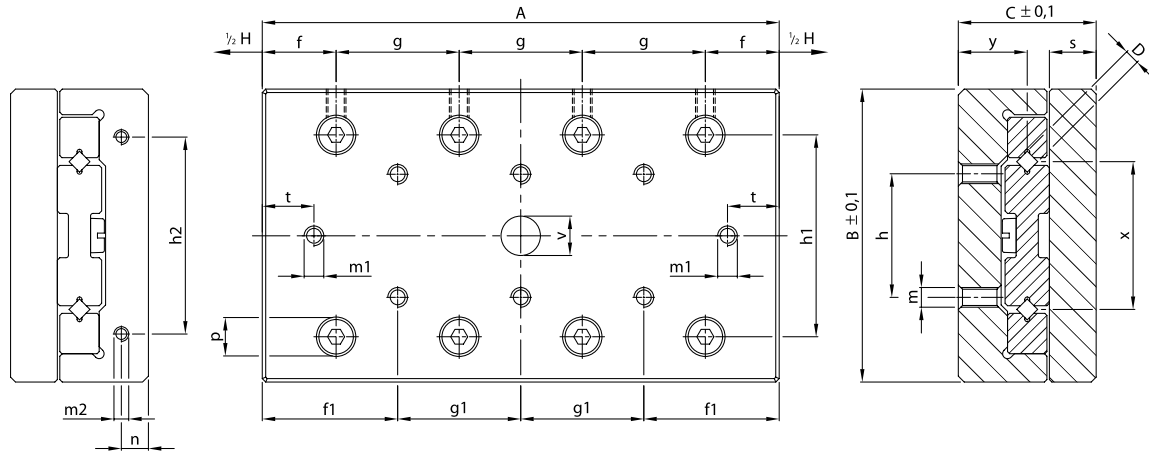

Layout mounting holes slide-base at page 24

Type	mm				Travel H		f	f1	g	g1	h	h1	h2	m	m1	m2	
	A	B	C	D	RTNA	RTLA											
RTA- 1520	25				10	-			1 x 10	-							
RTA- 1530	35				15	20			2 x 10	1 x 10							
RTA- 1540	45				20	30			3 x 10	2 x 10							
RTA- 1550	55				25	40			4 x 10	3 x 10							
RTA- 1560	65	30	15	1.5	30	50	7.5	12.5	5 x 10	4 x 10	10	18.4	12	M2.5	M2	M2	
RTA- 1570	75				35	60			6 x 10	5 x 10							
RTA- 1580	85				40	70			7 x 10	6 x 10							
RTA- 1590	95				45	80			8 x 10	7 x 10							
RTA-15100	105				50	90			9 x 10	8 x 10							
RTA- 2030	35				15	-			1 x 15	-							
RTA- 2045	50				22	30			2 x 15	1 x 15							
RTA- 2060	65				30	45			3 x 15	2 x 15							
RTA- 2075	80				37	60			4 x 15	3 x 15							
RTA- 2090	95	40	21	2	45	75	10	17.5	5 x 15	4 x 15	15	25	16	M3	M2.5	M2	
RTA- 2105	110				52	90			6 x 15	5 x 15							
RTA- 2120	125				60	105			7 x 15	6 x 15							
RTA- 2135	140				67	120			8 x 15	7 x 15							
RTA- 2150	155				75	135			9 x 15	8 x 15							
RTA- 3050	55				-	30			1 x 25	-							
RTA- 3075	80				37	55			2 x 25	1 x 25							
RTA- 3100	105				50	80			3 x 25	2 x 25							
RTA- 3125	130				62	105			4 x 25	3 x 25							
RTA- 3150	155				75	130			5 x 25	4 x 25							
RTA- 3175	180	60	25	3	87	155	15	27.5	6 x 25	5 x 25	25	41	40	M4	M4	M3	
RTA- 3200	205				100	180			7 x 25	6 x 25							
RTA- 3250	255				125	230			9 x 25	8 x 25							
RTA- 3300	305				150	280			11 x 25	10 x 25							
RTA- 3350	355				175	330			13 x 25	12 x 25							
RTA- 3400	405				200	380			15 x 25	14 x 25							



RTNA/ RTLA

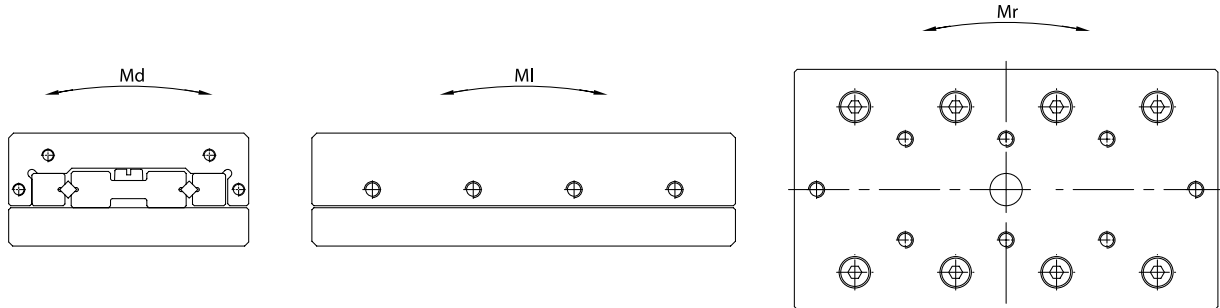

n	p	s	t	v	x	y	C in N		Weight in Kg	Md in Nm		MI in Nm		Mr in Nm								
							RTNA	RTLA		RTNA	RTLA	RTNA	RTLA	RTNA	RTLA							
2.45							260	-	0.04	1.4	-	1.2	-	1.5	-							
							364	312	0.05	2.1	2.1	2.5	1.9	1.9	1.7							
							520	416	0.06	3.5	2.8	4.4	3.1	2.6	2.1							
							624	520	0.08	4.2	3.5	5.6	4.4	3.1	2.6							
							2.5	4.6	5.25	3.7	4.5	13.5	7.5	780	572	0.09	4.9	3.5	7.5	5.0	4.0	2.9
							884	676	0.11	5.6	4.2	8.7	6.2	4.6	3.4							
							1040	780	0.12	7.0	4.9	10.6	7.5	5.5	4.0							
							1144	832	0.13	7.7	5.6	11.9	8.1	6.1	4.3							
3.4							1300	936	0.15	8.4	6.3	13.7	9.4	7.0	4.9							
							430	-	0.10	3.1	-	2.8	-	3.4	-							
							688	602	0.15	6.2	4.6	6.9	5.5	4.6	4.1							
							946	774	0.19	7.7	6.2	11.0	8.3	6.3	5.2							
							1204	946	0.24	10.8	7.7	15.1	11.0	8.2	6.3							
							1376	1118	0.28	12.4	9.3	17.9	13.8	9.5	7.5							
							1634	1290	0.33	13.9	10.8	22.0	16.5	11.4	8.8							
							1892	1376	0.37	17.0	12.4	26.1	17.9	13.4	9.5							
							2150	1548	0.42	18.6	13.9	30.3	20.6	15.4	10.8							
							2408	1720	0.46	21.7	15.5	34.4	23.4	17.5	12.1							
5.5							-	952	0.30	-	12.2	-	10.9	-	5.4							
							1496	1224	0.44	20.4	16.3	21.8	16.3	13.6	11.5							
							2040	1632	0.58	28.6	24.5	32.6	24.5	18.2	14.7							
							2448	1904	0.72	36.7	28.6	40.8	29.9	22.0	17.0							
							2992	2312	0.85	44.9	32.6	51.7	38.1	27.1	20.7							
							3536	2584	0.99	53.0	36.7	62.6	43.5	32.3	23.2							
							4080	2992	1.13	61.2	44.9	73.4	51.7	37.6	27.1							
							5032	3672	1.41	73.4	53.0	92.5	65.3	47.0	33.6							
							6120	4352	1.68	89.8	65.3	114.2	78.9	57.7	40.3							
							7072	5032	1.97	106.1	73.4	133.3	92.5	67.1	47.0							
							8160	5712	2.15	122.4	85.7	155.0	106.1	77.9	53.7							



RTNA/ RTLA

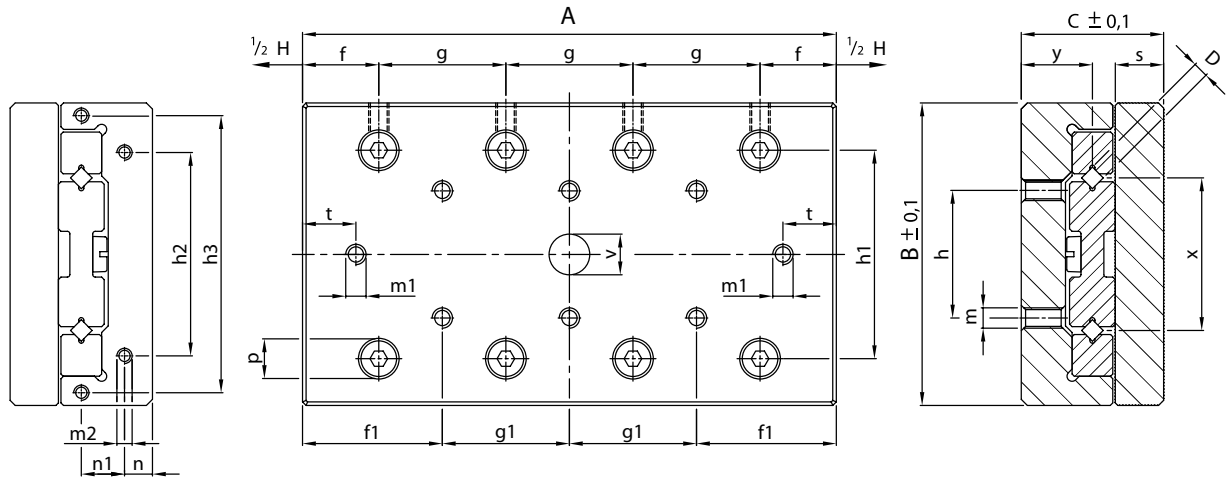

Layout mounting holes slide-base at page 25

Type	mm				Travel H		f	f1	g	g1	h	h1	h2	h3	m	m1
	A	B	C	D	RTNA	RTLA										
RTA- 4080	85				50	-			1 x 40	-						
RTA- 4120	125				75	90			2 x 40	1 x 40						
RTA- 4160	165				105	130			3 x 40	2 x 40						
RTA- 4200	205				130	170			4 x 40	3 x 40						
RTA- 4240	245	80	35	4	155	210	22.5	42.5	5 x 40	4 x 40	40	53	55	-	M5	M5
RTA- 4280	285				185	250			6 x 40	5 x 40						
RTA- 4320	325				210	290			7 x 40	6 x 40						
RTA- 4360	365				235	330			8 x 40	7 x 40						
RTA- 4400	405				265	370			9 x 40	8 x 40						
RTA- 6100	110				50	70			1 x 50	-						
RTA- 6150	160				75	120			2 x 50	1 x 50						
RTA- 6200	210				100	170			3 x 50	2 x 50						
RTA- 6250	260				125	220			4 x 50	3 x 50						
RTA- 6300	310				150	270			5 x 50	4 x 50						
RTA- 6350	360	100	40	6	175	320	30	55	6 x 50	5 x 50	50	65	60	92	M6	M6
RTA- 6400	410				200	370			7 x 50	6 x 50						
RTA- 6450	460				225	420			8 x 50	7 x 50						
RTA- 6500	510				250	470			9 x 50	8 x 50						
RTA- 6600	610				300	570			11 x 50	10 x 50						
RTA- 6700	710				350	670			13 x 50	12 x 50						
RTA- 9100	110				50	-	30	55	1 x 50	-						
RTA- 9200	210				100	150			1 x 100	-						
RTA- 9300	310				150	250			2 x 100	1 x 100						
RTA- 9400	410				200	350			3 x 100	2 x 100						
RTA- 9500	510	148.4	60	9	250	450	55	105	4 x 100	3 x 100	100	104	90	135	M8	M8
RTA- 9600	610				300	550			5 x 100	4 x 100						
RTA- 9700	710				350	650			6 x 100	5 x 100						
RTA- 9800	810				400	750			7 x 100	6 x 100						
RTA- 9900	910				450	850			8 x 100	7 x 100						
RTA- 91000	1010				500	950			9 x 100	8 x 100						

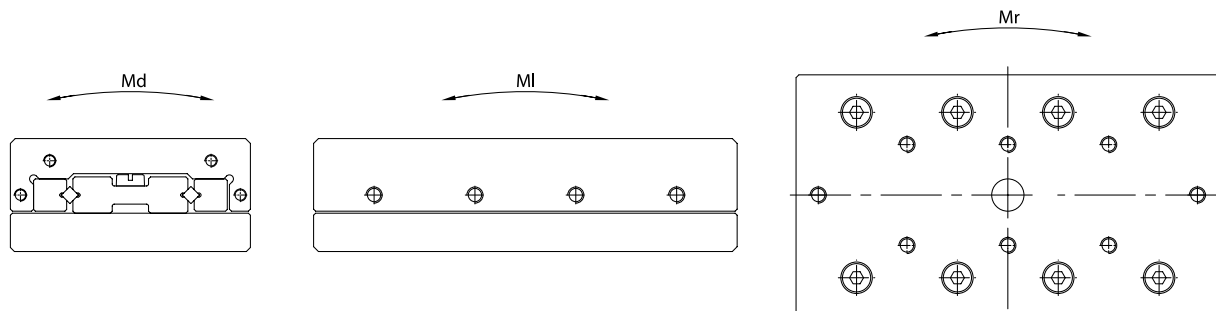

m2	n	n1	p	s	t	v	x	y	C in N		Weight in Kg	Md in Nm		MI in Nm		Mr in Nm	
									RTNA	RTLA		RTNA	RTLA	RTNA	RTLA	RTNA	RTLA
M3	6.5	-	10	10.5	9	9.5	40	18.5	1855	-	0.78	31.8	-	29.7	-	25.9	-
									2915	2650	1.14	53.0	53.0	59.4	51.9	36.5	33.5
									3710	3445	1.51	74.2	63.6	81.6	74.2	46.0	42.7
									4770	4240	1.87	95.4	84.8	111.3	96.5	59.6	52.7
									5830	4770	2.24	116.6	95.4	141.0	111.3	73.6	59.6
									6890	5565	2.60	137.8	106.0	170.7	133.6	87.9	70.1
									7950	6360	3.00	159.0	127.2	200.3	155.8	102.4	80.7
									9010	7155	3.30	180.2	137.8	230.0	178.1	116.9	91.5
									9805	7950	3.70	190.8	159.0	252.3	200.3	127.9	102.4
M4	8	15	11	12	10	11	46	20	4320	3780	1.65	97.2	72.9	97.2	77.8	68.7	62.2
									6480	5400	2.43	145.8	121.5	175.0	136.1	100.1	83.6
									8640	6480	3.20	194.4	145.8	252.7	175.0	135.4	100.1
									10800	8100	3.98	243.0	170.1	330.5	233.3	172.2	126.4
									13500	9720	4.75	291.6	218.7	427.7	291.6	219.3	153.7
									15660	11340	5.52	340.2	243.0	505.4	349.9	257.4	181.6
									17820	12420	6.30	388.8	267.3	583.2	388.8	295.6	200.4
									19980	14040	7.07	437.4	315.9	661.0	447.1	334.0	228.8
									22140	15660	7.86	486.0	340.2	738.7	505.4	372.5	257.4
									27000	18900	9.41	607.5	413.1	913.7	622.1	459.4	314.8
									31320	21600	10.91	704.7	486.0	1069.2	719.3	536.8	362.9
									M4	11	20	14	17	17	14	78	31
13500	10800	6.92	526.5	421.2	529.2	378.0	338.2	283.0									
21600	16200	10.50	842.4	631.8	982.8	680.4	534.6	400.1									
28350	21600	14.17	1053.0	842.4	1360.8	982.8	712.2	534.6									
35100	25650	17.84	1368.9	947.7	1738.8	1209.6	894.5	640.4									
43200	31050	21.51	1684.8	1158.3	2192.4	1512.0	1116.2	784.8									
49950	35100	25.18	1895.4	1368.9	2570.4	1738.8	1302.3	894.5									
56700	40500	28.95	2211.3	1579.5	2948.4	2041.2	1489.2	1042.1									
64800	44550	32.52	2527.2	1684.8	3402.0	2268.0	1714.0	1153.4									
71550	49950	35.98	2737.8	1895.4	3780.0	2570.4	1901.7	1302.3									



RTNA/ RTLA

Layout mounting holes slide-base

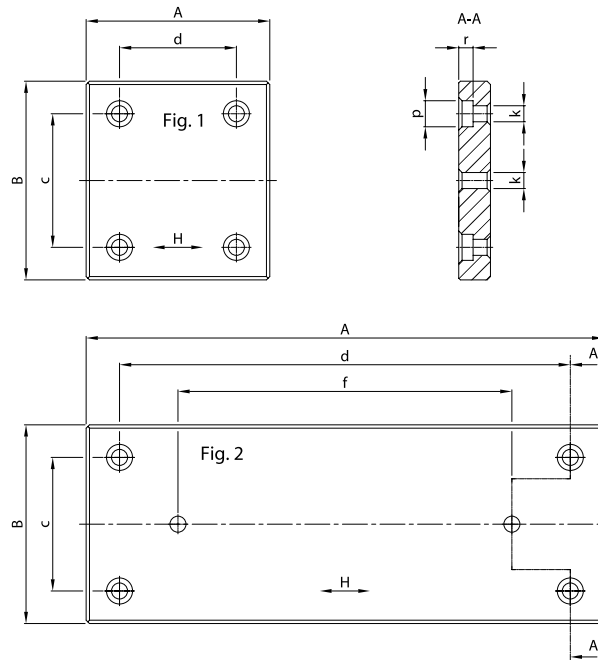

Type	mm A	B	c	d	e	f	g	k	p	r	Fig.
RTA- 1520	25			17	-	-	-				1
RTA- 1530	35			27	-	-	-				1
RTA- 1540	45			37	-	-	-				1
RTA- 1550	55			47	-	25	-				2
RTA- 1560	65	30	22	57	-	30	-	3	5	2.5	2
RTA- 1570	75			67	-	35	-				2
RTA- 1580	85			77	-	40	-				2
RTA- 1590	95			87	-	45	-				2
RTA- 15100	105			97	-	50	-				2
RTA- 2030	35			25	-	-	-				1
RTA- 2045	50			40	-	-	-				1
RTA- 2060	65			55	-	-	-				1
RTA- 2075	80			70	-	-	-				1
RTA- 2090	95			85	-	45	-				2
RTA- 2105	110	40	30	100	-	50	-	3.8	6.3	3.3	2
RTA- 2120	125			115	-	30	-				2
RTA- 2135	140			130	-	40	-				2
RTA- 2150	155			145	-	40	-				2
RTA- 3050	55			35	-	-	-				1
RTA- 3075	80			60	-	-	-				1
RTA- 3100	105			85	-	-	-				1
RTA- 3125	130			110	-	-	-				1
RTA- 3150	155			135	-	75	-				2
RTA- 3175	180	60	40	160	-	86	-	4.8	7.8	4.3	2
RTA- 3200	205			185	-	55	-				2
RTA- 3250	255			235	145	55	-				3
RTA- 3300	305			285	165	65	-				3
RTA- 3350	355			335	195	75	-				3
RTA- 3400	405			385	225	85	-				3



Layout mounting holes slide-base

RTNA/ RTLA

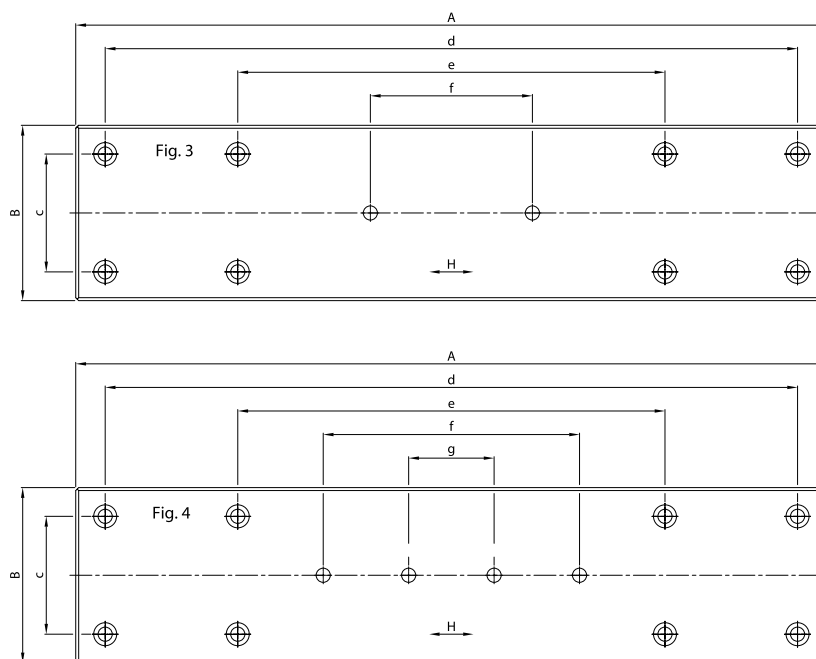

Type	mm A	B	c	d	e	f	g	k	p	r	Fig.
RTA- 4080	85			65	-	-	-				1
RTA- 4120	125			105	-	-	-				1
RTA- 4160	165			145	-	-	-				1
RTA- 4200	205			185	-	105	-				2
RTA- 4240	245	80	55	225	-	145	-	5.5	10	5.4	2
RTA- 4280	285			265	-	185	-				2
RTA- 4320	325			305	145	225	-				3
RTA- 4360	365			345	185	265	-				3
RTA- 4400	405			385	225	305	-				3
RTA- 6100	110			90	-	-	-				1
RTA- 6150	160			140	-	-	-				1
RTA- 6200	210			190	-	100	-				2
RTA- 6250	260			240	-	120	-				2
RTA- 6300	310			290	-	150	-				2
RTA- 6350	360	100	60	340	200	80	-	6.8	11	6.3	3
RTA- 6400	410			390	230	90	-				3
RTA- 6450	460			440	260	100	-				3
RTA- 6500	510			490	290	110	-				3
RTA- 6600	610			590	350	210	70				4
RTA- 6700	710			690	410	250	90				4
RTA- 9100	110			80	-	-	-				1
RTA- 9200	210			100	-	-	-				1
RTA- 9300	310			200	-	-	-				1
RTA- 9400	410			300	-	180	-				2
RTA- 9500	510	148.4	90	400	-	240	-	9	14	8.7	2
RTA- 9600	610			500	340	120	-				3
RTA- 9700	710			600	400	140	-				3
RTA- 9800	810			700	460	280	100				4
RTA- 9900	910			800	520	320	120				4
RTA- 91000	1010			900	600	360	120				4





Dust-Protected Precision Slides

RTNG



Precision dust-protected slides model RTNG are popular linear motion components for use under unfavourable environments. Thanks to the design, the linear bearings are protected against dust and chips and are therefore especially suitable for use under extreme conditions. Other characteristics are similar to conventional slides RTN/RTL

Material Table Bodies

Size $\varnothing 1.5$, $\varnothing 2$ and $\varnothing 3$ mm: steel, black oxide finish.
Size $\varnothing 6$ and $\varnothing 9$ mm: cast-iron, black oxide finish

Features and Specifications

- Incorporates pre-loaded linear bearings type RSD and double-sided track-rail, including roller cages.
- Linear strokes are limited by the endplates. It is not permitted to use this plates as machine endstops.
- Roller cage:
 - Size $\varnothing 1.5$ and $\varnothing 2$ mm: type CC
 - Size $\varnothing 3$, $\varnothing 6$ (pitch $t=9$ mm) and $\varnothing 9$ mm (pitch $t=14$ mm): type DD.Can be mounted in horizontal and vertical direction.
- Air gab (0.08 mm approx.) between slide-top and base.
- All mounting surfaces are precision ground.
One flank of the slide (the side opposite to the adjustment screws) is ground parallel to the linear bearings to serve as a Reference Face.
- The slide-top and - base are equipped with tapped attachment holes, drilled to a standard configuration.
- Running accuracies are shown on page 46.

Options

- Diam. $\varnothing 3$, $\varnothing 6$ and $\varnothing 9$ mm can be executed with dust protected wipers and seals for full covering, as showed on top of page 29 and 31. In this case it can lightly act as a brake on the running motion.
- Selected slides can be supplied with an height tolerance of ± 0.01 mm.
- Cages can be replaced by plastic crossed roller cages type KZR or type KKLK fitted with balls.
- Higher accuracy grade slides.
- Stainless steel version.

Notes by ordering

By ordering please specify the following:
1. Model no. and quantity.

Example: 2 pieces slide type RTNG-6200.



RTNG

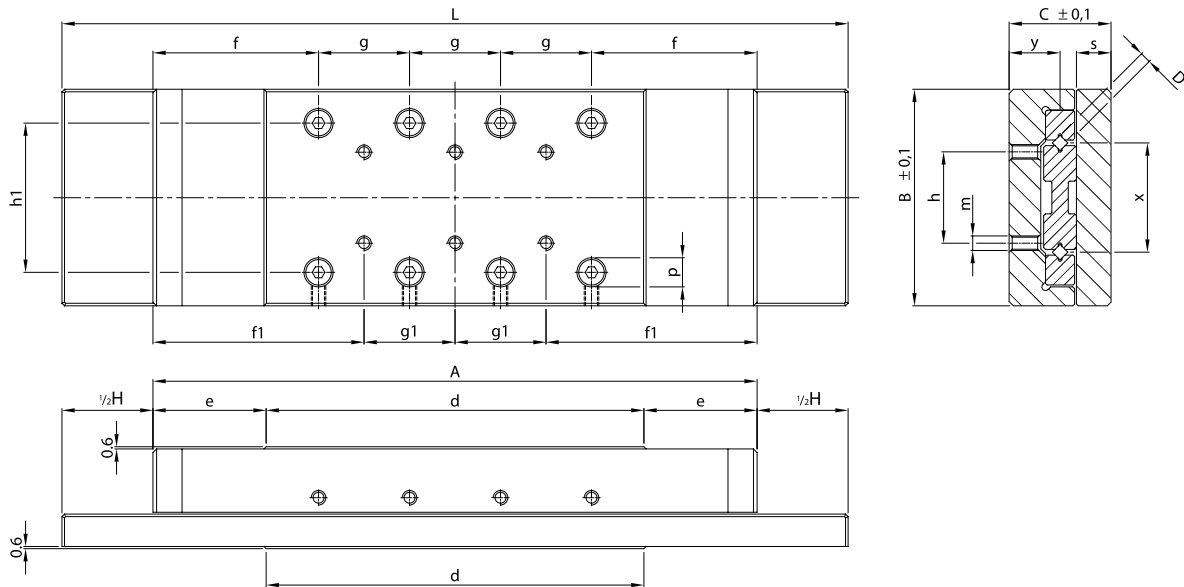

Layout mounting holes slide-base at page 33

Type	mm	B	C	D	L	Travel	d	e	f	f1	g	g1
	A					H						
RTNG- 1520	42				52	10	25	8.5	16	21	1 x 10	-
RTNG- 1530	57				72	15	35	11	18.5	23.5	2 x 10	1 x 10
RTNG- 1540	72				92	20	45	13.5	21	26	3 x 10	2 x 10
RTNG- 1550	87				112	25	55	16	23.5	28.5	4 x 10	3 x 10
RTNG- 1560	102	29.6	17	1.5	132	30	65	18.5	26	31	5 x 10	4 x 10
RTNG- 1570	117				152	35	75	21	28.5	33.5	6 x 10	5 x 10
RTNG- 1580	132				172	40	85	23.5	31	36	7 x 10	6 x 10
RTNG- 1590	147				192	45	95	26	33.5	38.5	8 x 10	7 x 10
RTNG-15100	162				212	50	105	28.5	36	41	9 x 10	8 x 10
RTNG- 2030	60				75	15	35	12.5	22.5	30	1 x 15	-
RTNG- 2045	82				104	22	50	16	26	33.5	2 x 15	1 x 15
RTNG- 2060	105				135	30	65	20	30	37.5	3 x 15	2 x 15
RTNG- 2075	127				164	37	80	23.5	33.5	41	4 x 15	3 x 15
RTNG- 2090	150	39.6	21	2	195	45	95	27.5	37.5	45	5 x 15	4 x 15
RTNG- 2105	172				224	52	110	31	41	48.5	6 x 15	5 x 15
RTNG- 2120	195				255	60	125	35	45	52.5	7 x 15	6 x 15
RTNG- 2135	217				284	67	140	38.5	48.5	56	8 x 15	7 x 15
RTNG- 2150	240				315	75	155	42.5	52.5	60	9 x 15	8 x 15
RTNG- 3050	91				116	25	55	18	33	45.5	1 x 25	-
RTNG- 3075	128				165	37	80	24	39	51.5	2 x 25	1 x 25
RTNG- 3100	166				216	50	105	30.5	45.5	58	3 x 25	2 x 25
RTNG- 3125	203				265	62	130	36.5	51.5	64	4 x 25	3 x 25
RTNG- 3150	241				316	75	155	43	58	70.5	5 x 25	4 x 25
RTNG- 3175	278	59.5	28	3	365	87	180	49	64	76.5	6 x 25	5 x 25
RTNG- 3200	316				416	100	205	55.5	70.5	83	7 x 25	6 x 25
RTNG- 3250	391				516	125	255	68	83	95.5	9 x 25	8 x 25
RTNG- 3300	466				616	150	305	80.5	95.5	108	11 x 25	10 x 25
RTNG- 3350	541				716	175	355	93	108	120.5	13 x 25	12 x 25
RTNG- 3400	616				816	200	405	105.5	120.5	133	15 x 25	14 x 25

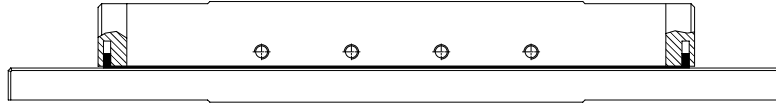

Optional: full covering for size 3, 6 and 9

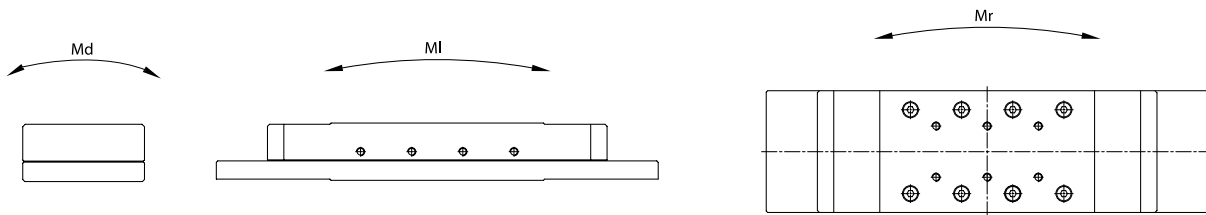

h	h1	m	p	s	x	y	C in N	Weight in Kg	Md in Nm	Ml in Nm	Mr in Nm
10	18.4	M2.5	4.6	6	13.5	8.75	260	0.17	1.4	1.2	1.5
							364	0.23	2.1	2.5	1.9
							520	0.29	3.5	4.4	2.6
							624	0.35	4.2	5.6	3.1
							780	0.41	4.9	7.5	4.0
							884	0.47	5.6	8.7	4.6
							1040	0.52	7.0	10.6	5.5
							1144	0.59	7.7	11.9	6.1
15	25	M3	6.3	7	18	10.75	430	0.37	3.1	2.8	3.4
							688	0.52	6.2	6.9	4.6
							946	0.63	7.7	11.0	6.3
							1204	0.81	10.8	15.1	8.2
							1376	0.94	12.4	17.9	9.5
							1634	1.10	13.9	22.0	11.4
							1892	1.24	17.0	26.1	13.4
							2150	1.38	18.6	30.3	15.4
2408	1.52	21.7	34.4	17.5							
25	41	M4	7.8	9.5	30	14	952	1.16	12.2	10.9	5.4
							1496	1.68	20.4	21.8	13.6
							2040	2.12	28.6	32.6	18.2
							2448	2.68	36.7	40.8	22.0
							2992	3.13	44.9	51.7	27.1
							3536	3.60	53.0	62.6	32.3
							4080	4.12	61.2	73.4	37.6
							5032	5.09	73.4	92.5	47.0
							6120	6.05	89.8	114.2	57.7
							7072	7.98	106.1	133.3	67.1
8160	9.90	122.4	155.0	77.9							



RTNG

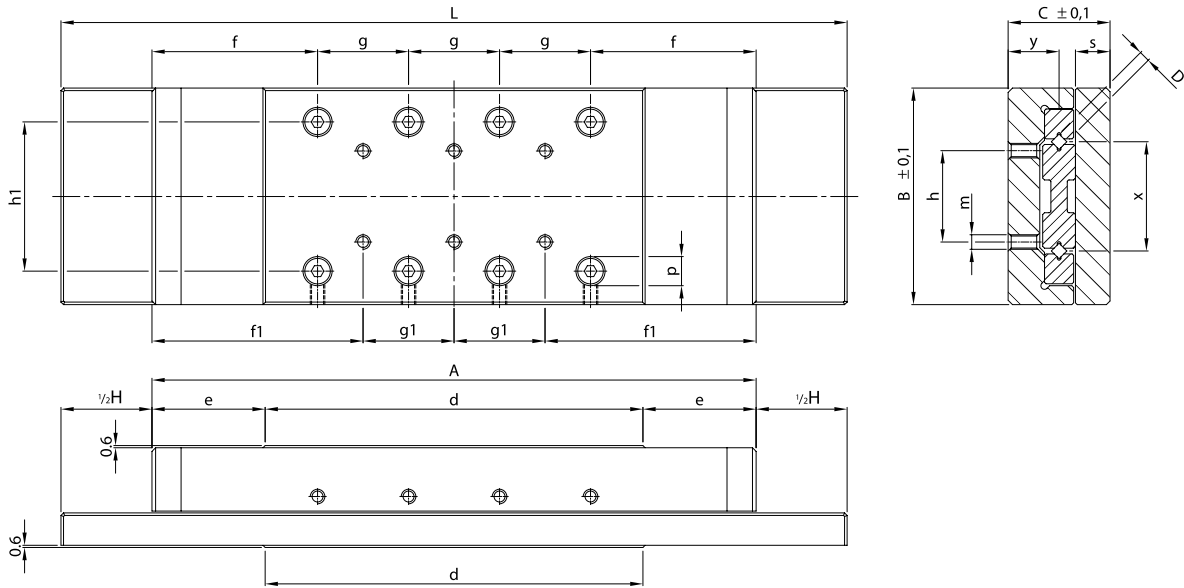

Layout mounting holes slide-base at page 33

Type	mm A	B	C	D	L	Travel H	d	e	f	f1	g	g1
RTNG-6100	173				223	50	110	31.5	61.5	86.5	1 x 50	-
RTNG-6150	248				323	75	160	44	74	99	2 x 50	1 x 50
RTNG-6200	323				423	100	210	56.5	86.5	111.5	3 x 50	2 x 50
RTNG-6250	398				523	125	260	69	99	124	4 x 50	3 x 50
RTNG-6300	473	99.5	45	6	623	150	310	81.5	111.5	136.5	5 x 50	4 x 50
RTNG-6350	548				723	175	360	94	124	149	6 x 50	5 x 50
RTNG-6400	623				823	200	410	106.5	136.5	161.5	7 x 50	6 x 50
RTNG-6450	698				923	225	460	119	149	174	8 x 50	7 x 50
RTNG-6500	773				1023	250	510	131.5	161.5	186.5	9 x 50	8 x 50
RTNG-9200	329				429	100	210	59.5	114.5	164.5	1 x 100	-
RTNG-9300	479	148	60	9	629	150	310	84.5	139.5	189.5	2 x 100	1 x 100
RTNG-9400	629				829	200	410	109.5	164.5	214.5	3 x 100	2 x 100
RTNG-9500	779				1029	250	510	134.5	189.5	239.5	4 x 100	3 x 100

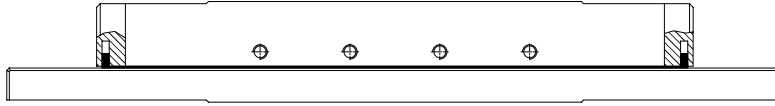

Optional: full covering for size 3, 6 and 9

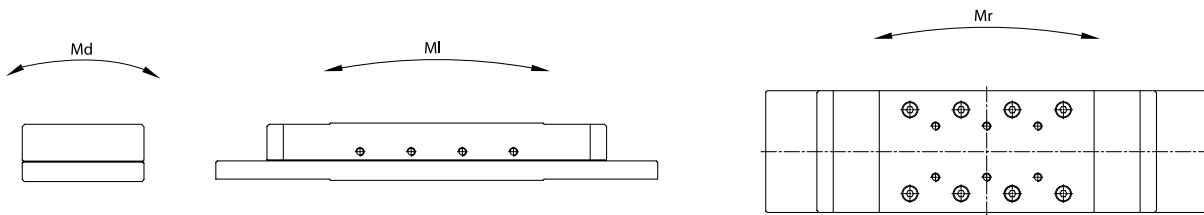

h	h1	m	p	s	x	y	C in N	Weight in Kg	Md in Nm	Ml in Nm	Mr in Nm
50	65	M6	11	14	46	23	4320	5.69	97.2	97.2	68.7
							6480	7.96	145.8	175.0	100.1
							8640	10.23	194.4	252.7	135.4
							10800	12.51	243.0	330.5	172.2
							13500	14.78	291.6	427.7	219.3
							15660	17.05	340.2	505.4	257.4
							17820	19.33	388.8	583.2	295.6
							19980	21.60	437.4	661.0	334.0
100	104	M8	14	17	78	31	22140	23.87	486.0	738.7	372.5
							13500	23.30	526.5	529.2	338.2
							21600	34.35	842.4	982.8	534.6
							28350	45.38	1053.0	1360.8	712.2
							35100	57.27	1368.9	1738.8	894.5

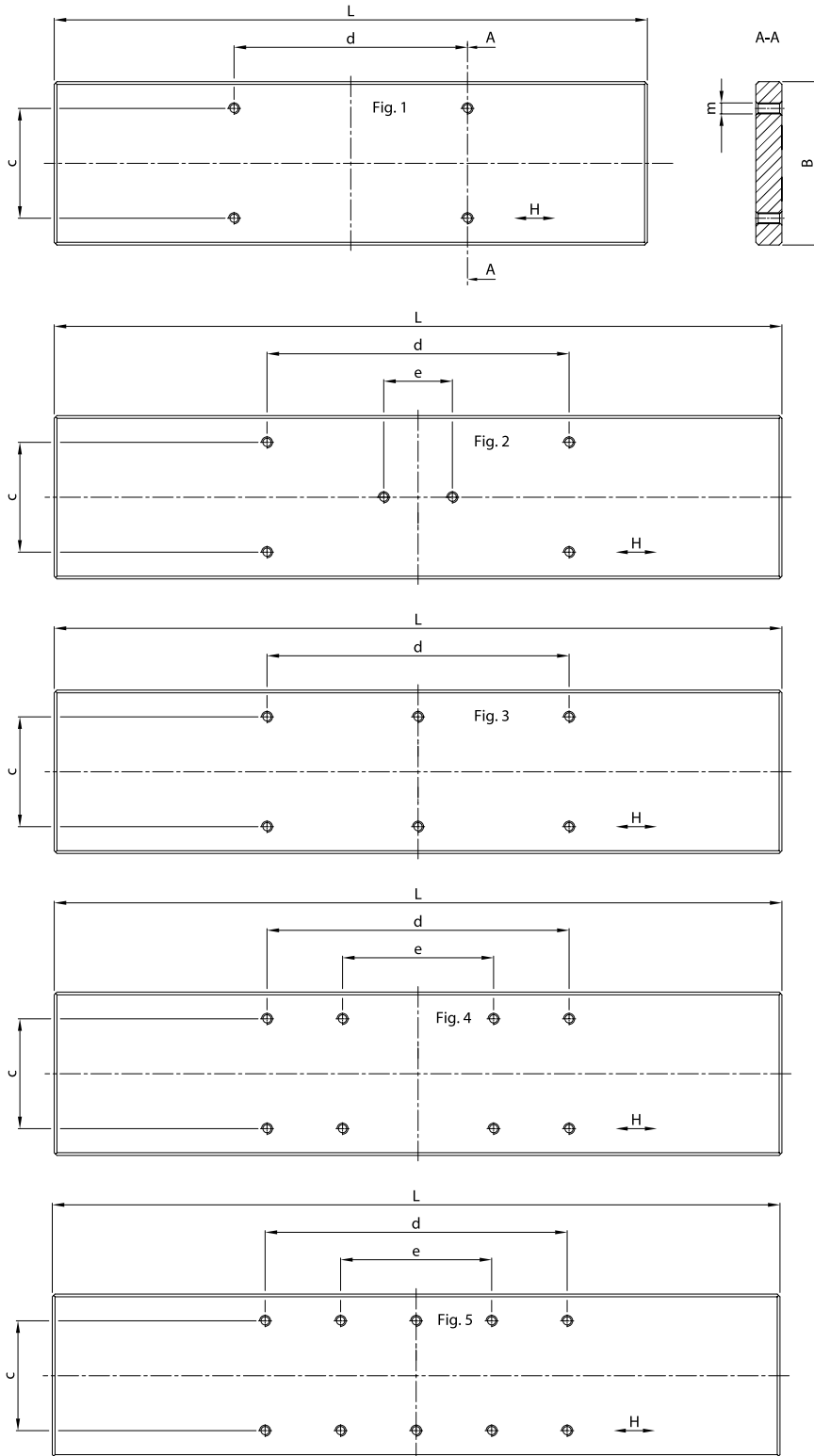



Type	mm L	B	c	d	e	m	Fig.
RTNG- 1520	52			17	-		1
RTNG- 1530	72			27	-		1
RTNG- 1540	92			37	-		1
RTNG- 1550	112			47	25		2
RTNG- 1560	132	29.6	22	57	30	M2.5	2
RTNG- 1570	152			67	35		2
RTNG- 1580	172			77	40		2
RTNG- 1590	192			87	45		2
RTNG-15100	212			97	50		2
RTNG- 2030	75			25	-		1
RTNG- 2045	104			40	-		1
RTNG- 2060	135			55	-		1
RTNG- 2075	164			70	-		1
RTNG- 2090	195	39.6	30	85	45	M3	2
RTNG- 2105	224			100	50		2
RTNG- 2120	255			115	30		2
RTNG- 2135	284			130	40		2
RTNG- 2150	315			145	40		2
RTNG- 3050	116			35	-		1
RTNG- 3075	165			60	-		1
RTNG- 3100	216			85	-		1
RTNG- 3125	265			110	-		3
RTNG- 3150	316			135	-		3
RTNG- 3175	365	59.5	40	160	-	M4	3
RTNG- 3200	416			185	65		4
RTNG- 3250	516			235	85		4
RTNG- 3300	616			285	95		4
RTNG- 3350	716			335	170		5
RTNG- 3400	816			385	195		5
RTNG- 6100	223			70	-		1
RTNG- 6150	323			120	-		1
RTNG- 6200	423			170	-		3
RTNG- 6250	523			220	-		3
RTNG- 6300	623	99.5	60	270	-	M6	3
RTNG- 6350	723			320	110		4
RTNG- 6400	823			370	130		4
RTNG- 6450	923			420	210		5
RTNG- 6500	1023			470	240		5
RTNG- 9200	429			160	-		1
RTNG- 9300	629	148	100	260	-	M8	1
RTNG- 9400	829			360	-		3
RTNG- 9500	1029			460	-		3





Frictionless Lightweight Slides

RTAM



Precision slides model RTAM are fine pre-loaded linear motion components, ready for mounting. This slidingtable, mainly made in aluminum, offers a long operation lifetime and is able to carry reduced loads and moments in every direction.

Material Table Bodies

Black anodized aluminum, mounting surfaces are finished by precision grinding.

Features and Specifications

- Incorporates pre-loaded linear bearings type RSD and center rail, including plastic roller cages, type KZR.
- Slide-top and -base have equal lengths.
- Can be mounted in horizontal and vertical direction.
- All mounting surfaces are precision ground.
One flank of the slide (the side opposite to the adjustment screws) is ground parallel to the linear bearings to serve as a Reference Face.
- The slide-top is equipped with tapped attachment holes, drilled to a standard configuration. The slide-base is equipped with countersunk-bored holes, which accept sockethead screws.
- Running accuracies are shown on page 46.

Options

- Cages can be replaced by plastic cages type KKLK fitted with balls.
- Higher accuracy grade slides.
- Stainless steel version.
- SF-Class technology for maximum performance.

Notes by ordering

By ordering please specify the following:

1. Model no. and quantity.

Example: 1 piece slide type RTAM-2075.



RTAM

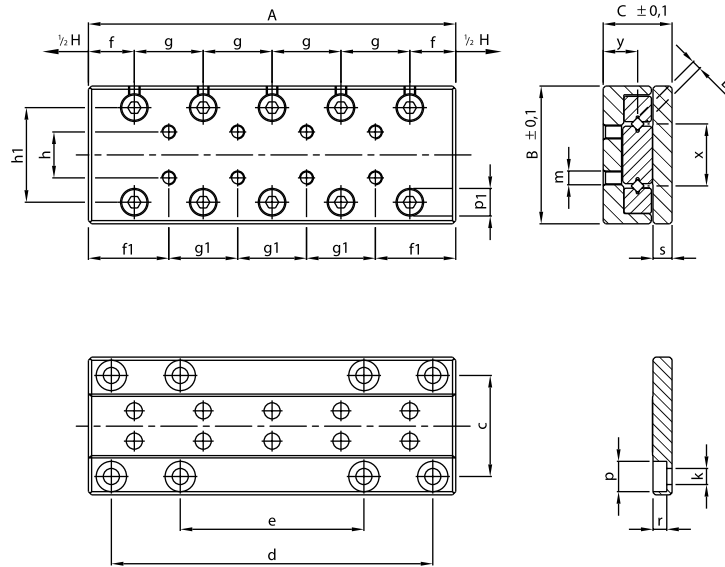

Type	mm				Travel H	c	d	e	f	f1	g	g1	h	h1	k
	A	B	C	D											
RTAM- 2045	50				25		40	-			2 x 15	1 x 15			
RTAM- 2060	65				38		55	-			3 x 15	2 x 15			
RTAM- 2075	80	30	15	2	51	22	70	40	17.5	10	4 x 15	3 x 15	10	20.5	3.5
RTAM- 2090	95				64		85	55			5 x 15	4 x 15			
RTAM- 2105	110				70		100	70			6 x 15	5 x 15			
RTAM- 2120	125				76		115	85			7 x 15	6 x 15			

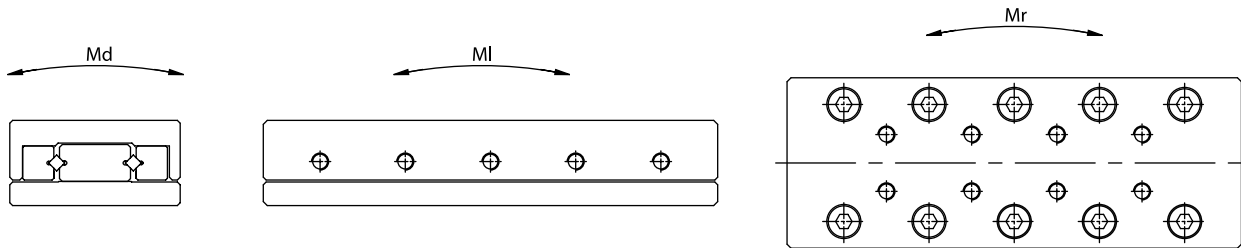

m	p	pl	r	s	x	y	C in N	Weight in Kg	Md in Nm	Ml in Nm	Mr in Nm
M3	6.6	6.3	3	4.1	13.5	7.5	430	0.09	2.3	3.4	2.1
							510	0.12	2.9	4.8	2.7
							650	0.15	3.5	6.2	3.3
							725	0.18	4.1	7.6	4.0
							800	0.20	4.6	9.6	5.0
							880	0.23	5.8	11.7	6.0





Low Profile Slides

RTS



PM frictionless low profile slides model RTS are fine pre-loaded linear motion components, ready for mounting. This low profile type offers an excellent running motion accuracy and is able to carry medium loads and moments in every direction.

Material Table Bodies

Steel, black oxide finish.

Features and Specifications

- 3 sizes.
- Incorporates pre-loaded linear bearings type RSD and double-sided center rail as slide-base (through hardened), including roller cages.
- Slide-top and -base have equal lengths.
- Can be mounted in horizontal and vertical direction.
- Rollercage:
 - Size $\varnothing 1.5$ and $\varnothing 2$ mm: type CC
 - Size $\varnothing 3$ mm: type DD.
- All mounting surfaces are precision ground.
One flank of the slide (the side opposite to the adjustment screws) is ground parallel to the linear bearings to serve as a Reference Face.
- The slide-top and -base are equipped with tapped attachment holes, drilled to a standard configuration.
- Running accuracies are shown on page 46.

Options

- Selected slides can be supplied with an height tolerance of ± 0.01 mm.
- Cages can be replaced by plastic crossed roller cages type KZR or type KKLK fitted with balls.
- Higher accuracy grade slides.
- Stainless steel version.
- SF-Class technology for maximum performance.
- High vacuum modification available.

Notes by ordering

By ordering please specify the following:
1. Model no. and quantity.

Example: 1 piece slide type RTS-2065.

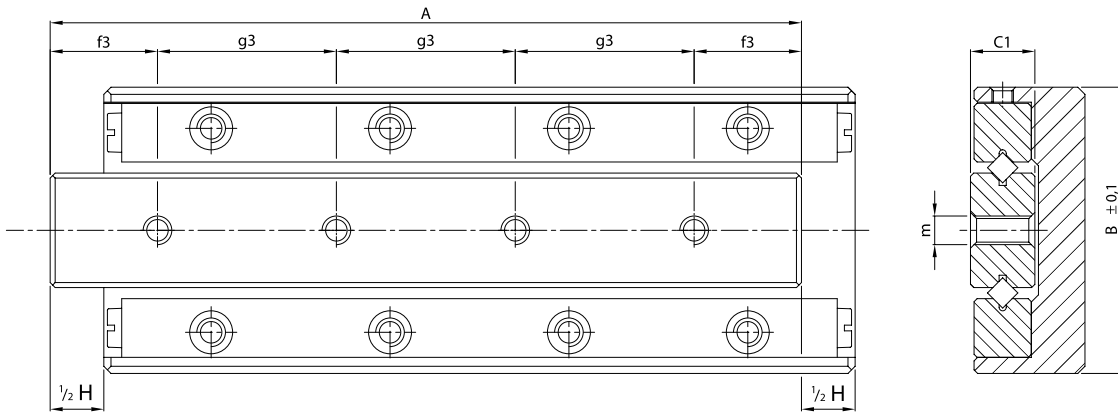

g2	g3	h	h1	m	p	x	y	C in N	Weight in Kg	Md in Nm	MI in Nm	Mr in Nm
1 x 18	2 x 7.5							208	0.03	0.8	0.6	0.8
1 x 20	2 x 10							364	0.04	1.4	2.5	1.5
1 x 28	3 x 10							468	0.05	1.8	3.7	2.0
1 x 30	4 x 10	14	12.6	M2.5	4.6	7.7	5.5	572	0.06	2.2	5.0	2.6
	5 x 10							676	0.07	2.6	6.2	3.2
	6 x 10							780	0.08	3.0	7.5	3.8
	7 x 10							936	0.09	3.6	8.7	4.7
	1 x 20							430	0.10	2.8	2.8	2.6
	2 x 15							602	0.12	3.9	5.5	3.5
	3 x 15							860	0.16	5.6	9.6	5.3
	4 x 15	22	20	M3	6	13	8.5	1032	0.19	6.7	12.4	6.6
	5 x 15							1290	0.23	8.4	16.5	8.6
	6 x 15							1462	0.26	9.5	19.3	9.8
	7 x 15							1720	0.29	11.2	23.4	11.9
	1 x 35							952	0.10	8.3	10.9	7.2
	2 x 25							1360	0.35	11.9	19.0	10.6
	3 x 25							1904	0.47	16.7	29.9	15.7
	4 x 25	30	28.5	M4	7.5	17.5	11.5	2312	0.59	20.2	38.1	19.6
	5 x 25							2856	0.70	25.0	49.0	24.9
	6 x 25							3264	0.82	28.6	57.1	29.0
	7 x 25							3672	0.92	32.1	65.3	33.0



Innovation





Frictionless Miniature Slides

PMM



The PMM slides are leading the trend of reduction in size and weight. This compact model is showing a consistent high running motion accuracy without clearance by an unsurpassed reliability. Thanks to the innovating design combined with a fine adjustment (pre-loading is by selection on ball diameter), these slides are showing an extreme low friction resistance, smooth running qualities and long operation lifetime.

Material Table Bodies

Stainless steel 1.4034, hardness 54-57 Hrc.

Features and Specification

- 3 Sizes.
- Ball cage is made of brass.
- Can be mounted in horizontal and vertical direction (*special designed U-shaped cage eliminates creeping of the cage and is limited by using inside screws*).
- Slide-top and center rail have equal lengths.
- Mounting surfaces are fine machined by precision grinding.
- *All the flanks of the slide are ground parallel to the guideways and can serve as Reference Faces.*
- The slide-top and center rail are provided with tapped attachment holes, drilled to a standard configuration.
- Running accuracies are shown on page 46.

Options

- Selected slides can be supplied with an height tolerance of ± 0.01 mm.
- High vacuum modification available.

Notes by ordering

By ordering please specify the following:
1. Model no. and quantity.

Example: 1 piece slide type PMM 2-30.



PMM 05

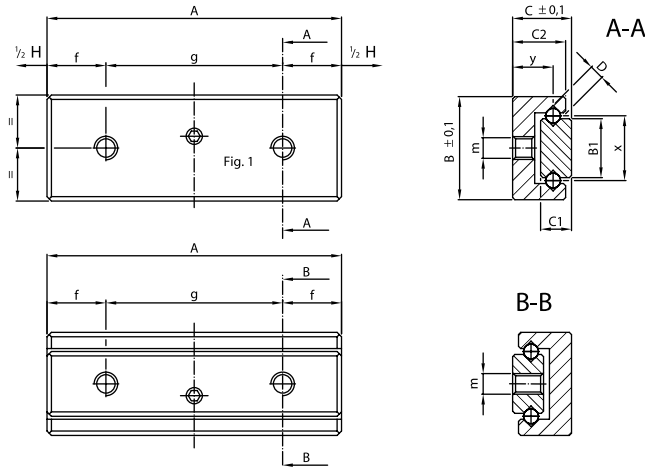

Type	mm A	B	C	D	Travel H	B1	C1	C2	f	g	h
PMM 05-10	10				5				2.5	1 x 5	
PMM 05-15	15	7	4	1	10	4	2.1	3.6	3.5	1 x 8	-
PMM 05-20	20				15				4	1 x 12	
PMM 05-25	25				20				4.5	1 x 16	
PMM 1-15	15				5				3.5	1 x 8	
PMM 1-20	20				10				4	1 x 12	
PMM 1-25	25				15				4.5	1 x 16	
PMM 1-30	30	10	6	1.5	20	5	3	5.5	5	1 x 20	4
PMM 1-35	35				25				5.5	1 x 24	
PMM 1-40	40				30				6	1 x 28	
PMM 1-45	45				35				6.5	1 x 32	
PMM 1-50	50				40				7	1 x 36	
PMM 2-30	30				20				5	1 x 20	
PMM 2-40	40				30				6	1 x 28	
PMM 2-50	50	15	8	2.5	40	8	4.5	7.5	7	1 x 36	7
PMM 2-60	60				50				7.5	3 x 15	
PMM 2-70	70				60				8	3 x 18	
PMM 2-80	80				70				10	3 x 20	

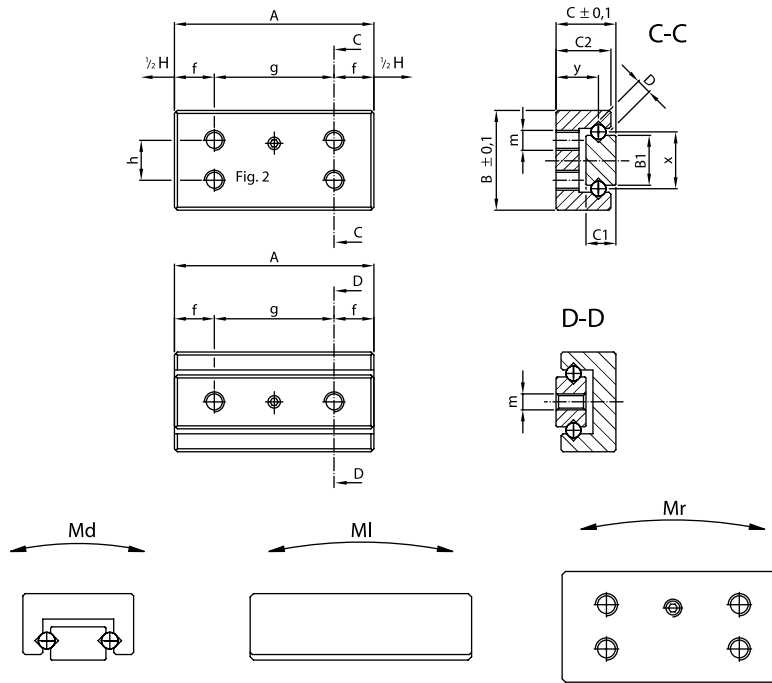

m	x	y	C in N	Weight in g	Md in Ncm	MI in Ncm	Mr in Ncm	Fig.
M1.6	4.4	2.75	23	2	4.5	1.5	3.2	1
			27	3	5.4	2.2	3.8	1
			36	4	7.2	3.4	5	1
			45	5	9	4.7	6.3	1
M2	5.7	4.25	60	5	15	9	15.5	2
			75	7	18.7	11	19.5	2
			75	10	18.7	11	19.5	2
			90	12	22.5	16	23.7	2
			105	14	26.2	19	28.1	2
			120	17	30	22.5	32.4	2
			135	19	33.8	27	36.8	2
M2.5	8.8	5.5	195	28	78	40	69.8	2
			234	36	95	50	83.6	2
			273	45	109.2	62.5	98.7	2
			312	54	124.8	80	113.5	2
			390	64	156	109.2	143.8	2
			429	73	171.6	125	159.1	2



Running Accuracies

PM slides are delivered with accuracies as mentioned in the table below. The checks on the slides are made in unloaded horizontal position. The shown values can also be used for 2-axis combinations. If so, please refer to the belonging slide-strokes. In case more axis are used in a

combination it will be more complicated and we offer in these questions our experience. On request the precision slides will be delivered with a certificate of compliance, measured with a HP laser accuracy equipment. Special higher accuracy grade slides can be requested.

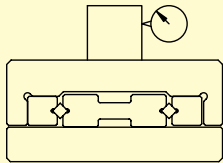
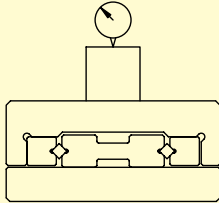
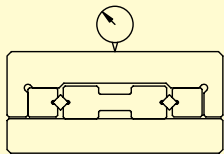
Type	A. in mm.	 Straight Line Accuracy in μm^* over travellength on the side	 Flatness Accuracy in μm^* over travellength on top	 Parallism in μm^* , neutral position on slide top
RT (RTN/RTL)	25 - 50	2	2	5
	55 - 95	3	2	6
	105 - 155	4	3	7
	160 - 305	4	3	8
	310 - 510	4	4	10
	510 - 710	5	4	13
	810 - 1010	5	5	15
RTA (RTNA/RTLA) Aluminum	25 - 50	2	2	5
	55 - 95	3	2	5
	105 - 155	4	3	8
	160 - 305	4	3	10
	310 - 510	4	4	15
	510 - 710	5	4	20
	810 - 1010	5	5	25
RTNG	52 - 91	2	2	5
	106 - 166	3	2	6
	171 - 314	3	3	7
	317 - 517	4	3	10
	524 - 817	4	4	13
	824 - 1028	5	5	15
RTS	25 - 45	3	3	2
	55 - 95	4	4	4
	105 - 155	5	5	5
PMM	15 - 30	3	4	5
	35 - 50	4	4	6
	60 - 80	5	6	8

Tolerance on the height: ± 0.1 mm.

* $1 \mu\text{m}$ = 1 micron is approximately 0.000040 inches

Most of the slides can be supplied with a height tolerance of ± 0.01 mm.

1. Straight Line Accuracy: this is the amount of error deviates from the ideal straight line of travel in the vertical plane.

2. Flatness Accuracy: this is the amount of error deviates from the ideal straight line of travel in the horizontal plane.

Parallism in μm , neutral position on slide top: the parallism of the table surfaces occurs unloaded on a flat, horizontal surface in zero-position.

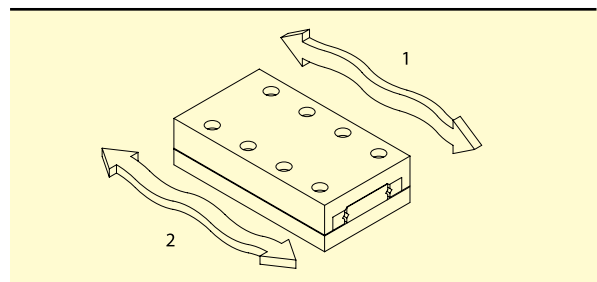



Special Customer Design

At PM, we are able to supply linear bearings, frictionless slides and positioning tables to your specific application requirements. Relying on long history experience, know-how and manufacturing capabilities, our product engineers are able to design the most technical and economical solutions according to your demands, even when they're extreme. Special customer designed slides can be delivered within 6 weeks after approval.

Please, feel free to contact one of our product specialists for more information.

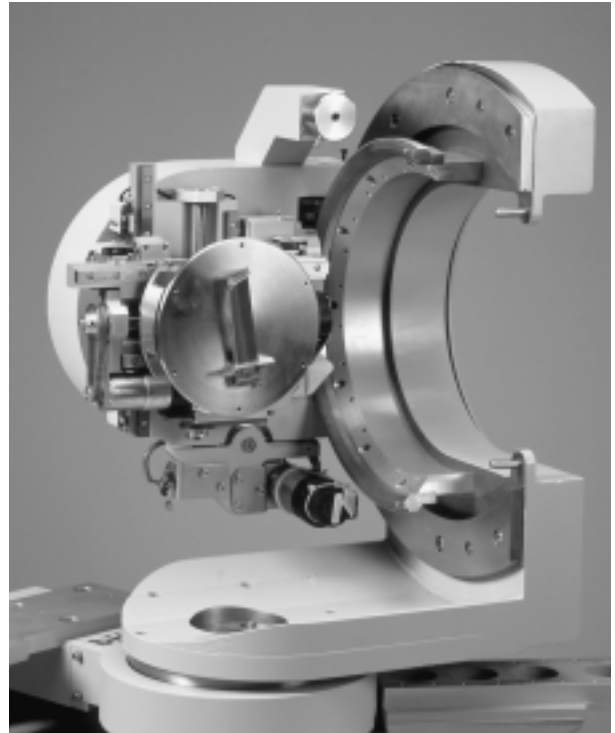

Our local representative:

The Netherlands
PM - BEARINGS BV
P.O. Box 174, 7700 AD
Dedemsvaart, The Netherlands
Phone +31 (0)523 61 22 58
Fax +31 (0)523 61 52 90
E-mail: info@pmbearings.nl

USA
PM - BEARINGS LLC
9355-A Founders St.
Fort Mill, SC 29708
Phone +1 803-396-5544
Fax +1 803-396-7810
E-mail: info@pmbearings-usa.com

Singapore
PM-PBA Pte. Ltd.
157 Sin Ming Road
#02-01 Amtech Building
Singapore 575624
Phone +65-655 279 92
Fax +65-655 269 92
E-mail: info@pba.com.sg

www.pmbearings.nl
Cat. Nr. PS04.1-E